

CE

Denne manual
er på engelsk

SCATTERBIRD

GAS POWERED BIRD SCARER

MARK 4



ALWAYS WEAR SAFETY PROTECTION
TO HSE/EN SPECIFICATIONS



Operator's Handbook

fuglekontrol.dk

Contents

Important Safety Information	Page 3
Setting Up & Assembly	Page 4
Barrel Assembly	Page 5
12v Power Source (External)	Page 5
12v Power Source (Internal)	Page 6
Gas Connection	Page 8
Leg Assembly	Page 9
App Installation & Set-Up - iOS/iPhone	Page 10
Checking the Scatterbird App Will Work	Page 10
Checking that Bluetooth is Active	Page 11
Downloading the Scatterbird App	Page 12
Things to Check Before Running the App	Page 13
App Installation & Set-Up - Android	Page 14
Checking the Scatterbird App Will Work	Page 14
Downloading the Scatterbird App	Page 16
Checking that Bluetooth is Active	Page 17
Things to Check Before Running the App	Page 18
Using the Scatterbird App	Page 19
App Overview	Page 19
Weekly Program	Page 21
Daily Program	Page 25
Connecting to Scatterbird	Page 27
Multiple Scatterbirds	Page 31
Additional App Features	Page 33
Changing the Pin Code	Page 33
Multiple Phones	Page 34
Troubleshooting	Page 36
Scatterbird MK4 Wiring Diagram	Page 41
Scatterbird MK4 Parts List & Diagram	Page 42
EC Certificate of Conformity	Page 44
Scatterbird MK4 Specifications	Page 44

Important safety information

SAVE THESE INSTRUCTIONS FOR FUTURE REFERENCE

Please refer to the safety instructions, assembly instructions and parts list before setting-up, operating, maintaining and cleaning your Scatterbird MK4. Keep this Instruction Manual safe so you may refer to it at any time.



Safety Rules

WARNING

Read and understand all the instructions before use.

Failure to follow the instructions in this manual may cause fire, hearing loss or other injury.

This machine is strictly to be operated by one person.

Never place any object in front of or inside the barrel.

WARNING:

When using this machine, basic safety precautions should be followed to reduce risk of personal injury and machine damage. Read all instructions thoroughly before attempting to operate the machine.

The Scatterbird MK4 is designed to make loud bangs for scaring birds. The use of ear defenders to protect hearing is recommended for anyone operating or likely to be near a unit which is operating.

We recommend hearing muffs to: **BS EN 352-1:2002** with a noise reduction rating of 30 or above.

1. **Keep the work space free from obstacles which could cause an accident. Ensure a clear working area of at least 2m is maintained to eliminate risk of fire.**
2. **Keep children away from the machine.** Children should never be allowed near to the machine or to operate the machine.
3. **Safety equipment must be used.** When operating the Scatterbird MK4 earmuffs should be worn, see above.
4. **Only genuine Scatterbird MK4 accessories and parts can be used as replacements.**
5. **MAINTENANCE:** For your own safety, the care and maintenance of the Scatterbird MK4 should be on a regular basis.
6. **This machine can only be used to scare birds.** Using the Scatterbird MK4 in other ways may cause injuries or damage to property and invalidate any guarantee.
7. **ATTENTION:** the warnings, alerts and instructions in this manual cannot cover all situations. The operator must use basic common sense and caution at all times.



**WARNING FIRE RISK
ALWAYS KEEP A 2 METRE
CLEAR AREA AROUND
THE SCATTERBIRD MK4**

Portek cannot be held liable for any injuries or damages that may occur, if the Scatterbird MK4 is used in any inappropriate way, and/or if the device has been modified in any way.

© Copyright 2018

Nothing within this edition may be copied, reproduced or stored onto a retrieval system without the written approval of Portek. Specifications, descriptions and illustrative material in this manual are as accurate as known at the time of publication, but are subject to change without notice.

Setting up and assembly

The Scatterbird MK4 comes almost fully assembled.

The Scatterbird MK4 follows in the Portek line of propane operated guns, which have set the industry standard for Birdscaring for decades. The Scatterbird MK4 is the new generation model. It has a robust polyethylene moulding with a stainless steel barrel and fittings. This is complemented with state of the art electronics to enable a wide range of easily programmed features.

Though the Scatterbird MK4 is an easy to operate machine we recommend reading this instruction book fully before operating. It covers safe use, setup, programming and a troubleshooting guide. Please keep this instruction book safe for future use should it be needed.



Setting up and assembly

Barrel Assembly

Assembly of the barrel to the main unit is done by using the pre-drilled holes and the two 8mm self tapping screws provided. Remove the screws from the inner barrel (where they have been placed for transportation).

Slide the plastic “sounding” barrel over the stainless steel inner barrel, carefully lining up the holes, before screwing the screws back through the holes to secure the plastic part of the barrel.

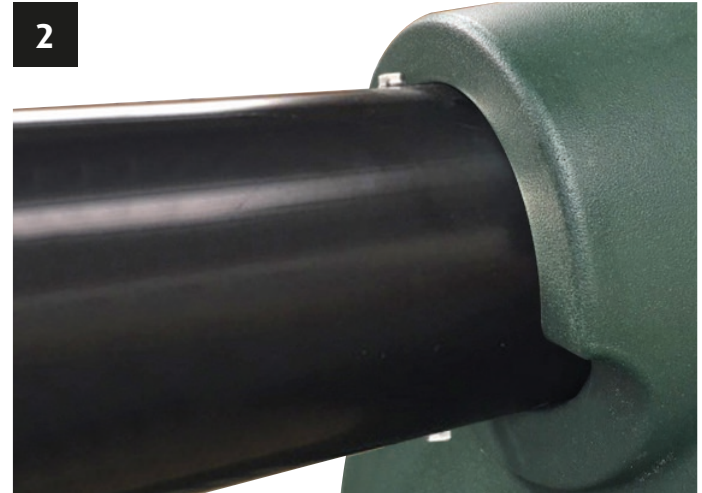

12V Power Source Assembly

The Scatterbird MK4 requires a 12V power supply to drive the electronics. There are two options available:

1. Using the Supplied 12V Lead

Complete with crocodile clips, these leads are already attached to the electronics of the Scatterbird unit. You simply need to connect the red to the positive terminal and the black to the negative terminal of your own 12V battery.

Please make sure that the battery is in good condition. If it is old then it may not hold charge and the voltage will drop quickly. If this happens then the electronics will not operate.

For safety the electronics will not operate the gas gun when the voltage drops below 10V.



Setting up and assembly

2. Using the Rechargeable Battery

The advantage of this is that the unit is much more transportable. The battery will have sufficient capacity to last a number of weeks, even when the unit is set to fire frequently. The battery, charger and short battery lead needed are all available as accessories from Portek Ltd.

To use the rechargeable battery firstly remove the bottom back panel by undoing the 6 screws. Pull apart the white connector block that holds the main wiring harness to the crocodile battery lead. **DO NOT** pull apart by holding the wires, hold the connector block.

Note: The now unused crocodile lead can be tidied with a cable tie for future use, or, if wanted, can be removed completely from the unit. To do this remove the spade terminals from the crocodile clips, then feed the wires through the backplate. This needs to all be done before the backplate is re-attached to the unit. The wires can then be stored for use later if required.

1



2



Setting up and assembly

Feed the connector block on the wiring harness through the moulded in hole at the back right of the moulding (Photo 3).

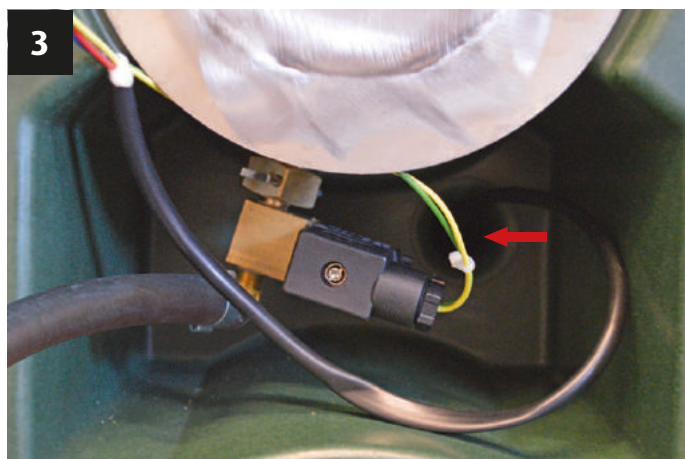

Undo the side panel of the machine. This can be done by undoing the 3 screws on the side of the Scatterbird MK4 unit (Photo 4).



Attach the short battery lead connector block to the wiring harness connector block, which you have fed through into this side cavity (Photo 5).

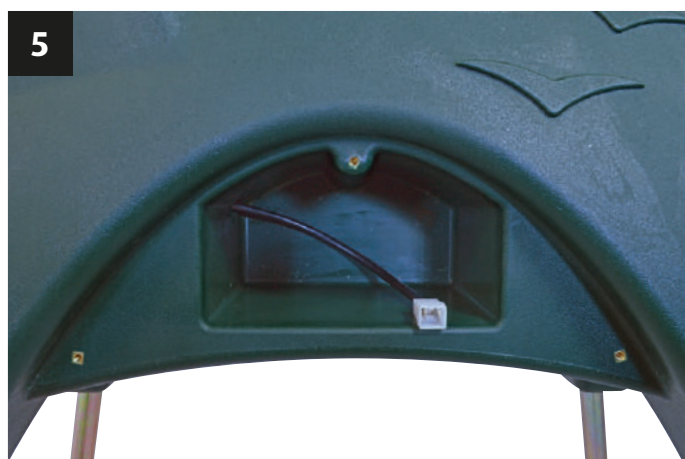

Make sure that you have the pip on the connector blocks matched together. These ensure that the polarity of the wires is correct when they are connected to the battery (Photo 6). The spade connectors on this short lead can now be attached to the rechargeable battery. Make sure that the red wire is connected to the red, positive terminal and the blue wire is attached to the black, negative terminal. The battery can then be placed in the housing and the side panel replaced.



Setting up and assembly

Gas Connection

The unit comes with a standard "POL" type regulator, which is fixed at 1 bar of pressure.

DO NOT use any other type of regulator. The gas regulator can be attached to any size of propane gas bottle that has a POL connection (this is the standard type used in UK).

When the regulator is connected make sure that the fitting is tight and that there is no gas leakage. You can do this by using a leak detecting fluid to make sure no bubbles are visible at the joint (alternatively some washing up liquid with a small amount of water is also very effective).

Billedet viser gas regulator til UK. Korrekt DK gas regulator medfølger.



WARNINGS:

1. When the regulator is not connected to a gas bottle protect it from ingress of dust or dirt by placing it in a plastic bag, if possible, tying off the open end with a piece of string, elastic band or similar. Though the regulator and the solenoid valve have filters in them to stop dirt blocking the solenoid or jet it is always better to avoid getting debris into the gas line in the first place. If it's not there it cannot block anything! Failure to keep the gas line clean could lead to the solenoid being held open when it should be closed, potentially causing a fire.
2. When the unit is being transported always ensure that the gas is turned off at the gas bottle.

The Scatterbird MK4's legs raise the unit off the ground and allow the full force of the "BANG" to be heard with maximum effect.

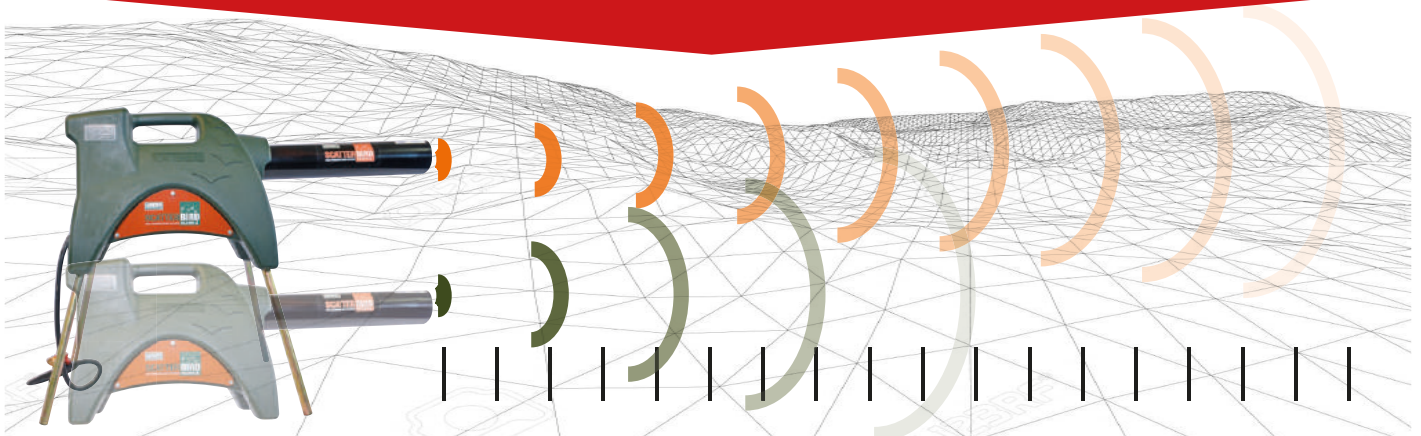

Setting up and assembly

Leg Assembly

The four legs supplied can be used at the discretion of the user. The advantage of using them is twofold. Firstly they will extend the area that the Scatterbird MK4 will be effective. Secondly they will lift the main unit off the ground, avoiding ground water. Attaching the legs is quite simple.

Firstly align a leg with the moulded-in insert that it will slide into. These all have an angle to them as can be seen from the picture of the complete unit.

Press the sprung loaded pips into the leg so you can start to ease the leg into the main unit (Photo 2 & 3). It can be easier to do this one pip at a time, twisting the leg slightly to get the pip to go in.

When the pips are in, the leg can be pushed as far as it will go (Photo 4). You may well be able to feel when the pips locate in a groove in the inside of the moulded-in metal inserts. Repeat this process for all four legs.

Leg Removal

If you want to remove the legs then they will pull straight out, the sprung loaded pips releasing the legs from the main unit.

1



2

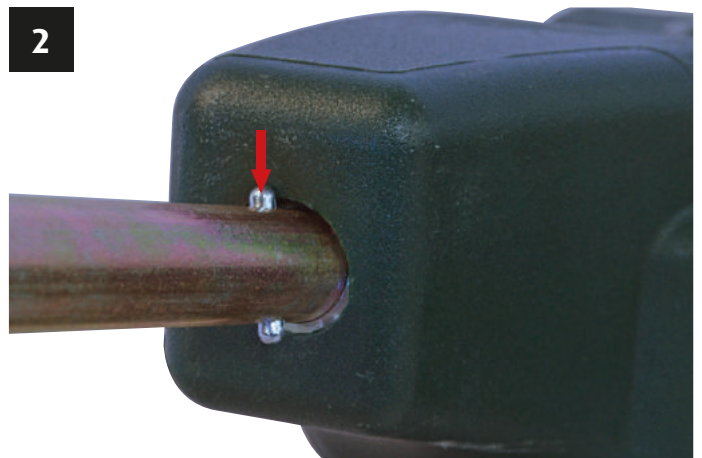

3

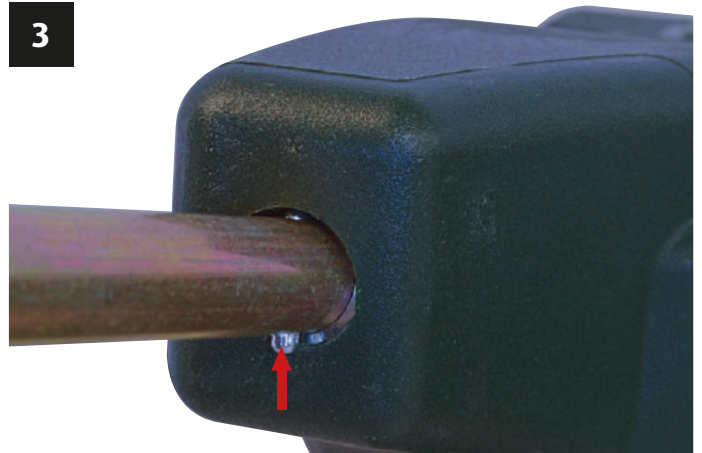

4

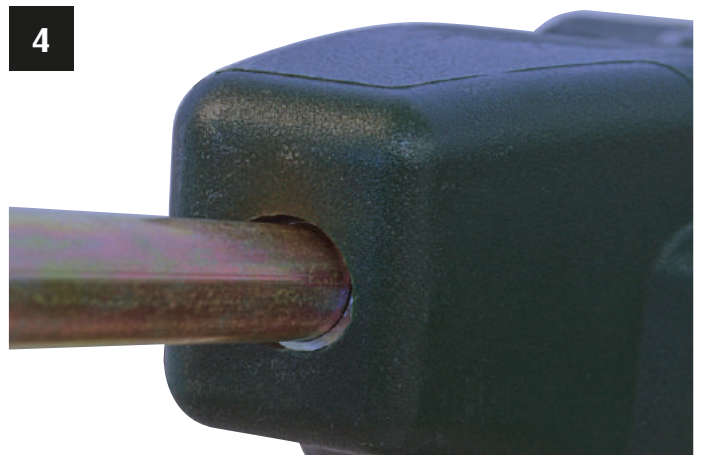

App installation and set up - iOS

Checking the Scatterbird App will run on your iPhone

The Scatterbird MK4 can only be used with phones that have the capabilities necessary. It can be used with iPhones that have software version 'iOS 9' or higher. If you need to check to see what version your smart phone is then the below details will help you do this:

1. From the home page of your iPhone click on the "Settings" icon (Fig 1). Depending on how you have your iPhone set up, this may appear in a different location and you may need to slide the screen to left or right to see the icon.
2. Next click on the "General" icon to see the general phone settings information screen (Fig 2). You may need to scroll up or down to find it.
3. Select the "About" option (Fig 3). Click on this to get to the next screen. Once again you may need to scroll up or down to find it.
4. Locate the iOS software version information by scrolling up or down. On this example the iOS software version is shown as 11.4.1 (Fig 4). The first part of the version, 11 in this case, means that the App will run on the phone because it is higher than 9.

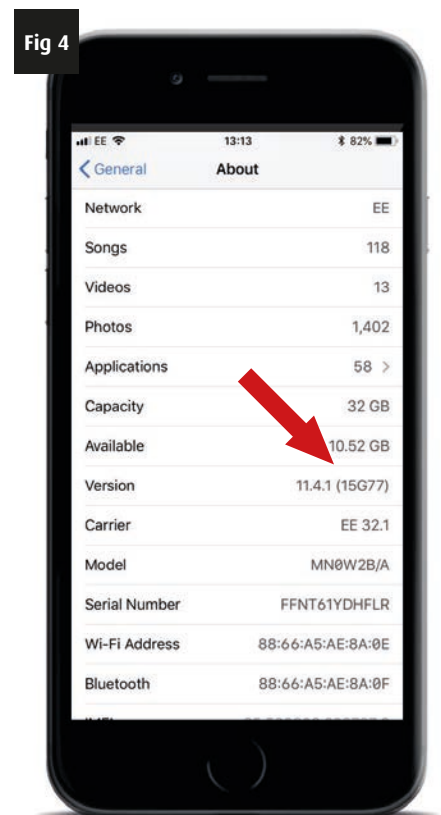
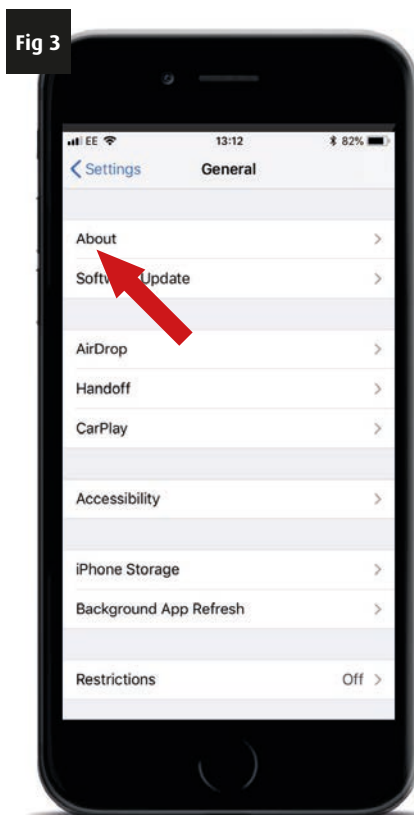
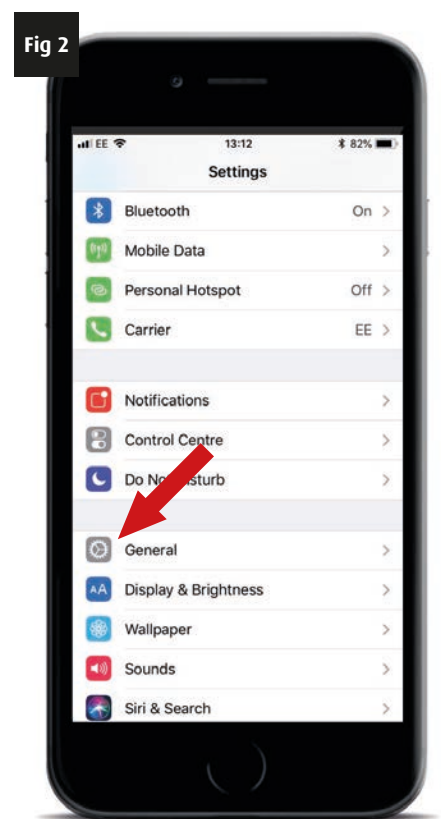

Remember: You may be able to view the complete screen, but you may need to scroll up/down to see all the different items.

App installation and set up - iOS

Checking that Bluetooth is active on your iPhone

Your iPhone talks to the Scatterbird MK4 using Bluetooth. Make sure that Bluetooth is switched on.

1. From the home page of your iPhone click on the "Settings" icon (Fig 1). Depending on how you have your iPhone set up, this may appear in a different location and you may need to slide the screen to left or right to see the icon.
2. Find the "Bluetooth" icon. You may need to scroll up or down to find it. Check to the Bluetooth is switched on, if it is active you should see "On" to the right hand of the Bluetooth icon (Fig 2).
3. If Bluetooth is switched off, click the icon, then the on/off switch, your Bluetooth should now become active and a list of Bluetooth devices will appear below the on/off switch. The Bluetooth icon will also appear in the top right hand of the phone screen (Circled, Fig 4).

Your phone should now be ready for starting the Scatterbird App!

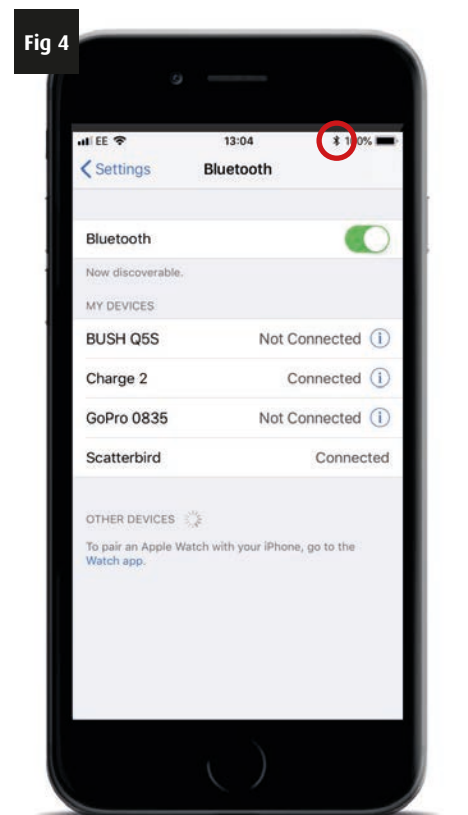
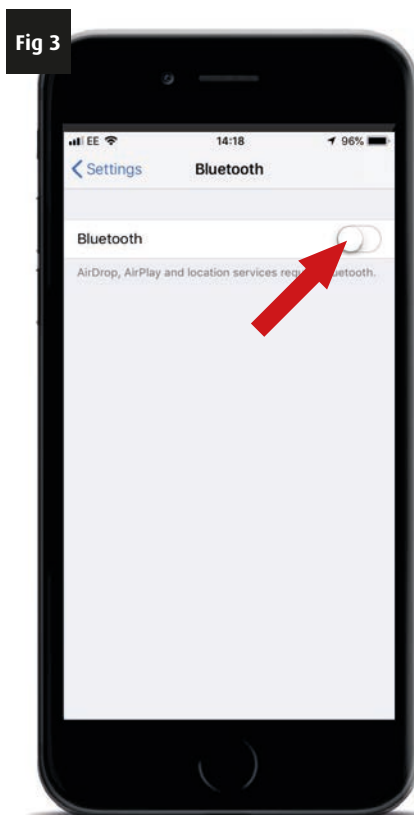
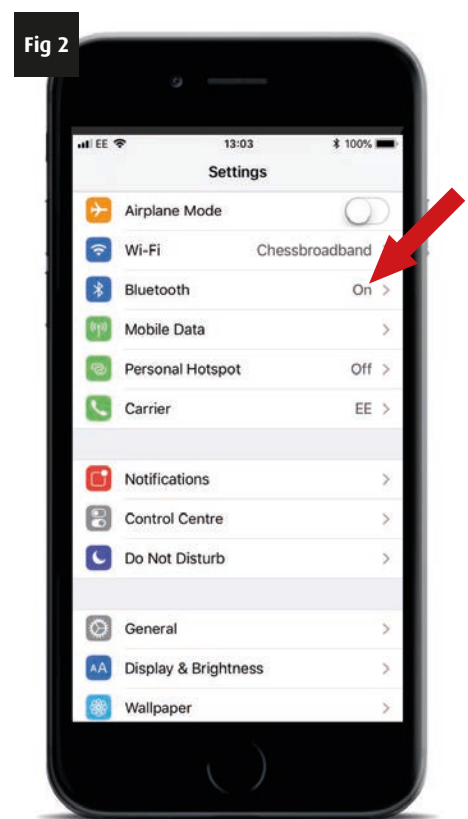

Remember: You may be able to view the complete screen, but you may need to scroll up/down to see all the different items.

App installation and set up - iOS

Downloading the Scatterbird App to your iPhone

1. To download the Scatterbird App click on the "App Store" icon on the home page of your iPhone (Fig 1). Depending on how you have your iPhone set up, this may appear in a different location and you may need to slide the screen to left or right to see the icon.
2. On entering the App Store, click on the "Search" icon, then type "Scatterbird" into the search bar (Fig 2 & 3).
3. The App will come up in the search, you can either click the "GET" button (Fig 4) to download it instantly or click the icon to find out more about the application, including it's features, ratings and update history.

Fig 1



Fig 2

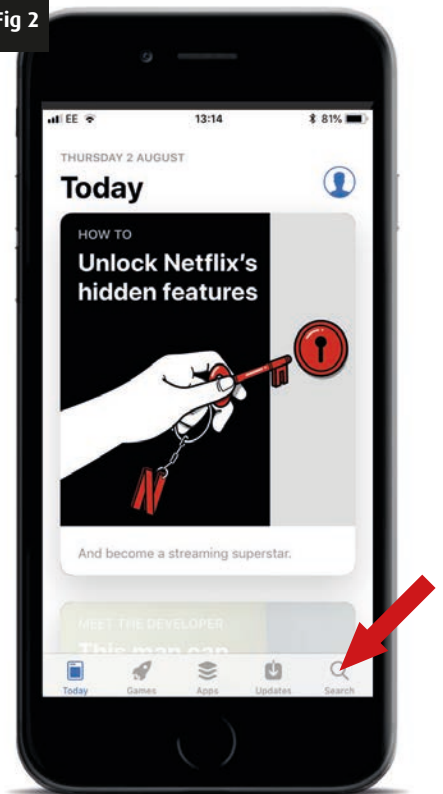

Fig 3

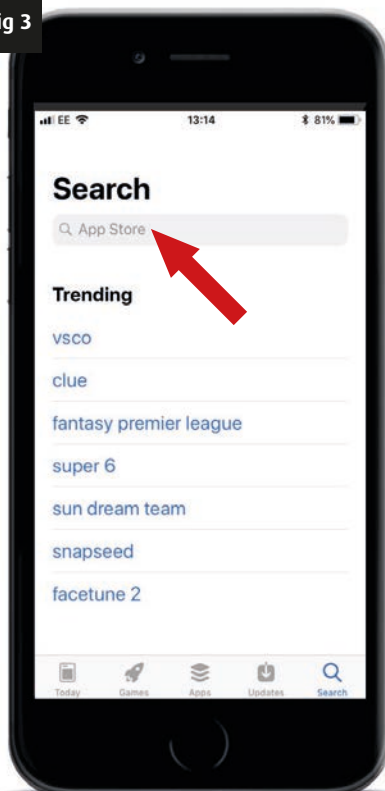
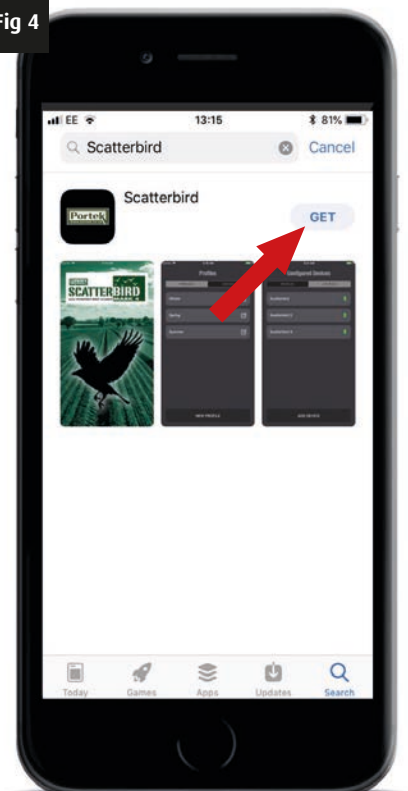

Fig 4



Remember: You may be able to view the complete screen, but you may need to scroll up/down to see all the different items.

App installation and set up - iOS

4. While in the main information pages you can also download the App by clicking on "GET" (Fig 5).
5. Once the App has download, it can be found on the home page of your iPhone. Simply click the "Scatterbird" App icon to launch the programme (Fig 6).

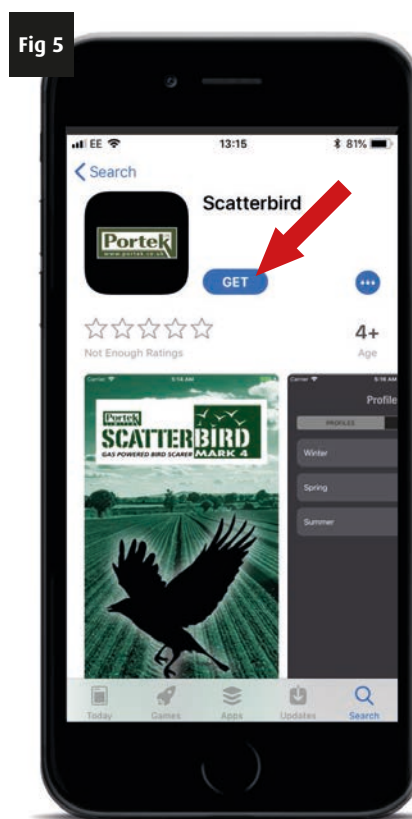

Remember: You may be able to view the complete screen, but you may need to scroll up/down to see all the different items.

Things to check before running the Scatterbird App on your iPhone

For the dawn and dusk feature to work, your phone needs to be connected to either your phone network or the internet when you program the profiles.

From the comfort of your home, you can easily set up the profiles, and then later send them to your Scatterbird when in the field. Your Scatterbird MK4 will function 100% without this feature if you are not connected to the internet when programming.

App installation and set up - Android

Checking the Scatterbird App will run on your Android Phone

The Scatterbird MK4 can only be used with phones that have the capabilities necessary. It can be used with many phones that are not "Windows". These are all called Android because this is the software they all use. So, if it's made by Samsung, HTC, Nokia, Sony, etc. if they are not a "Windows" phone, then they will be an "Android" phone. Android phones must have software version '4.4' or higher and have 'Bluetooth Low Energy' (Bluetooth 4.0 or higher). If you need to check to see what version your smart phone is then the below details will help you do this:

1. Press the icon on the main screen. This will bring up the main menu of items on your phone. Scroll around until you find the "Settings" icon and click to get to the next screen (Fig 1).
2. Scroll to find the "About Phone" listing and click it (Fig 2).
3. Find "Software Information" and click it (Fig 3).
4. Locate the Android software version information. This needs to be 4.4 or higher. On this example the software version is shown as 8.0.0 (Fig 4).

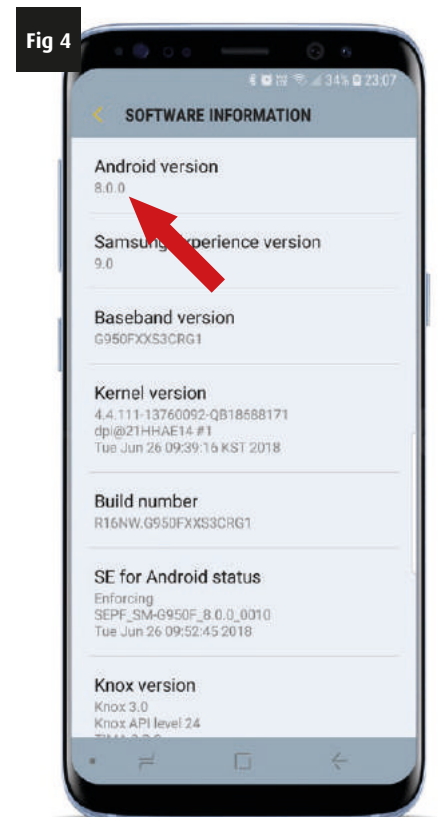
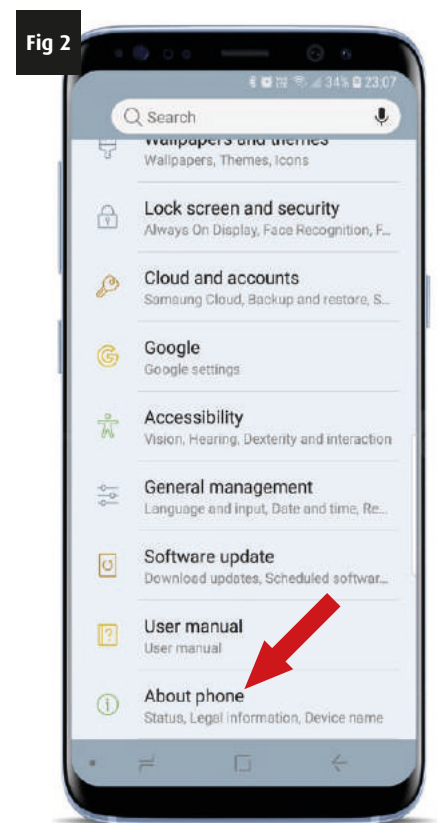

Remember: You may be able to view the complete screen, but you may need to scroll up/down to see all the different items.

App installation and set up - Android

If your phone is an older model, running an earlier version of Android software version (example: 4.2.2). It would not have the capability to operate the Scatterbird MK4. If this is the case, then we sell a phone which can be used. This comes with the software preloaded and some profiles already programmed to get you started.

If your phone has a version of 4.4 or above then there is an additional check which can be done by going to the "Google Play Store" (Fig 5).

If the search for "Scatterbird" brings up the App then it will almost definitely work on your android phone (Fig 6). This is because the App store will only show apps that should work with your phone, so it will check that you have Bluetooth 4.4 or above.

Phone manufacturers alter some functionality from the normal sometimes, so occasionally a phone will meet the above tests but still fail to work with the App properly. If this is the case then another phone may need to be used or a pre-setup phone from Portek can be purchased at a competitive price.

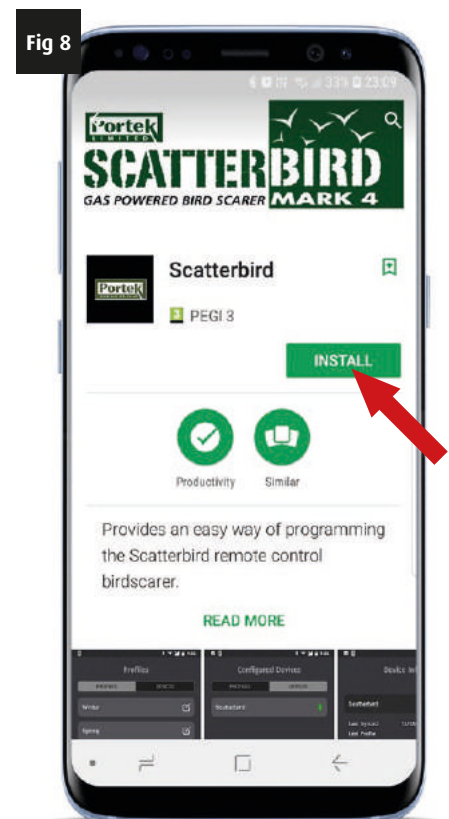
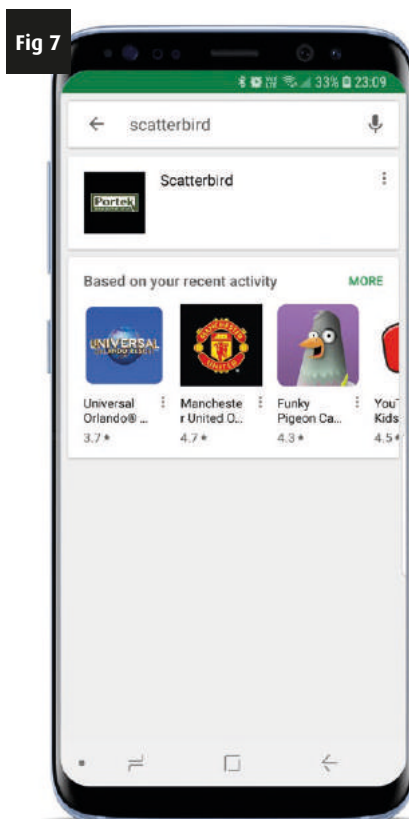
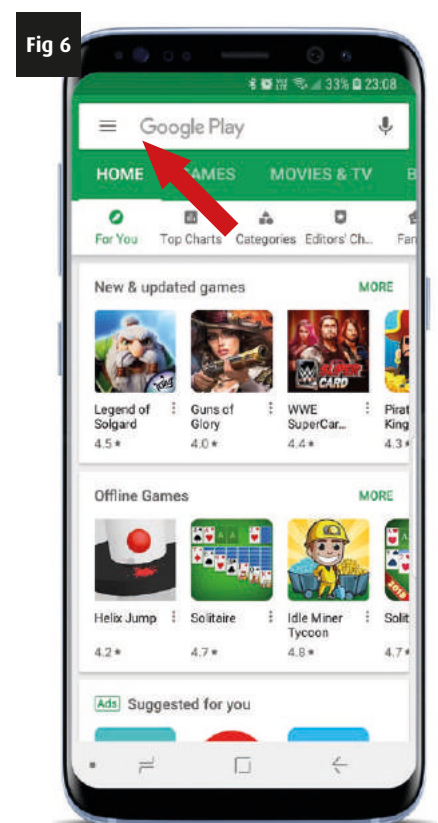
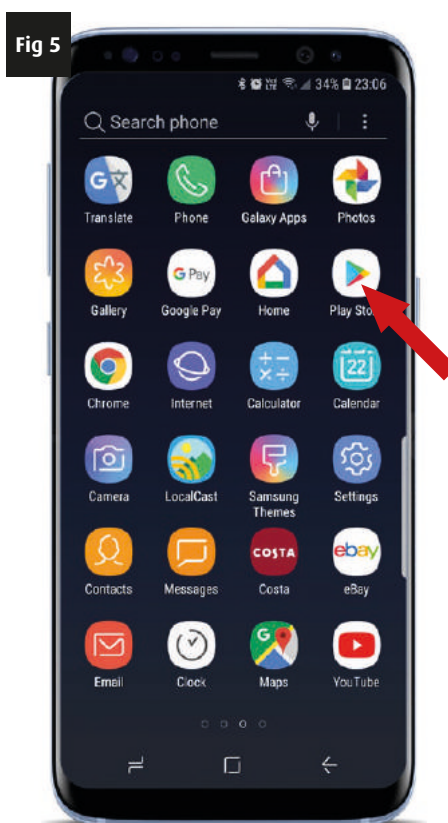

Remember: You may be able to view the complete screen, but you may need to scroll up/down to see all the different items.

App installation and set up - Android

Downloading the Scatterbird App to your Android Phone

1. To download the Scatterbird App click on the "Google Play Store" icon (Fig 1).
2. On entering the Play Store, type "Scatterbird" in to the search bar at the top of the screen (Fig 2).
3. The "App" will come up in the search results (Fig 3). Click on the App icon to find out more about the application, including it's features, ratings and update history. While in the main information pages you can download the App by clicking on "INSTALL" (Fig 4).

If the App does not come up when you search the store for your Android phone then your phone is not compatible with the App.

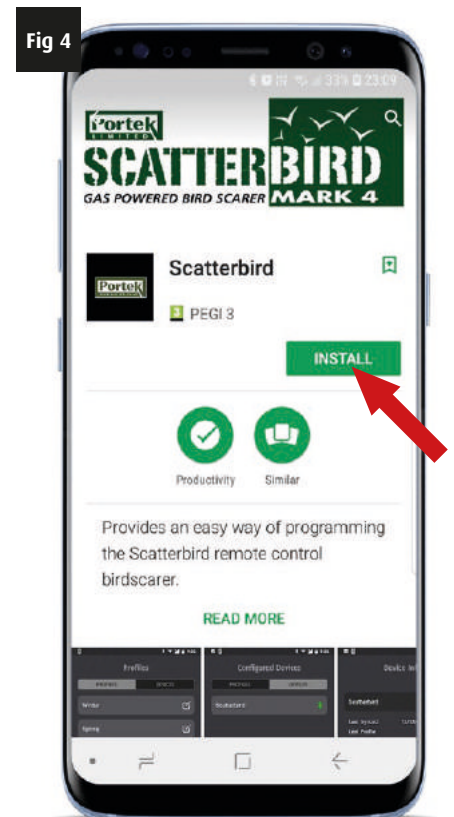
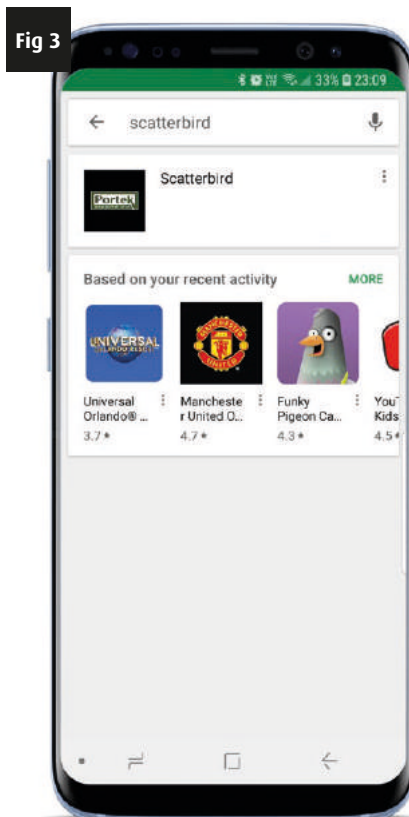
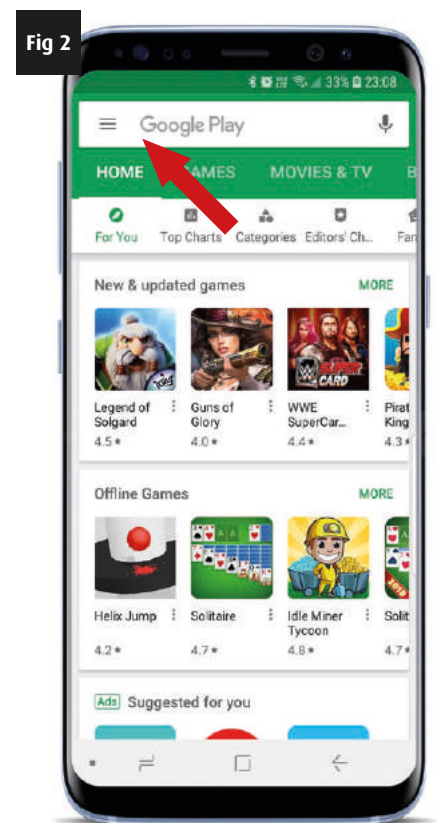

Remember: You may be able to view the complete screen, but you may need to scroll up/down to see all the different items.

App installation and set up - Android

Checking that Bluetooth is active on your Android Phone

Your Android Phone talks to the Scatterbird MK4 using Bluetooth. Make sure that Bluetooth is switched on.

1. From the home page click on the "Settings" icon (Fig 1). Depending on how you have your phone set up, this may appear in a different location and you may need to slide the screen to left or right to find the icon.
2. Select "Connections" from the list (Fig 2) and find the "Bluetooth" information. You may need to scroll up or down to find it. Check to see if Bluetooth is active (Fig 3).
3. If Bluetooth is switched on, and active you should see either "On" under the Bluetooth heading or a coloured slider switch to the right of the Bluetooth icon (Fig 4).

However if Bluetooth is switched off, click the on/off slider switch, your Bluetooth should now become active and the Bluetooth icon will also appear in the top right hand of the phone screen (Circled, Fig 4).

Your phone should now be ready for starting the Scatterbird App!

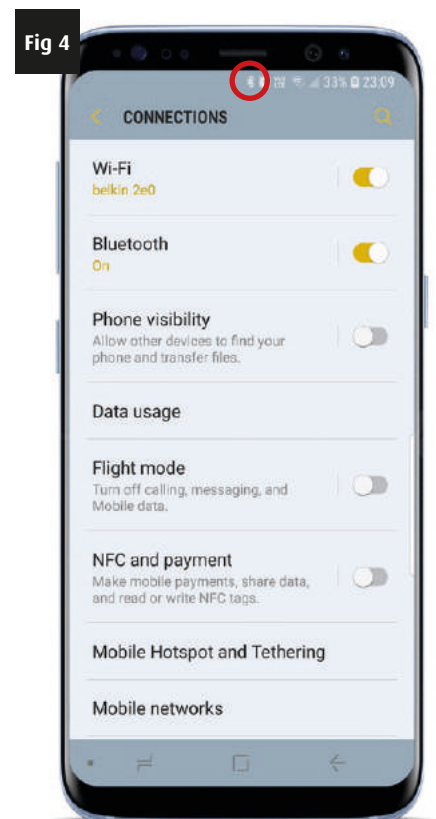
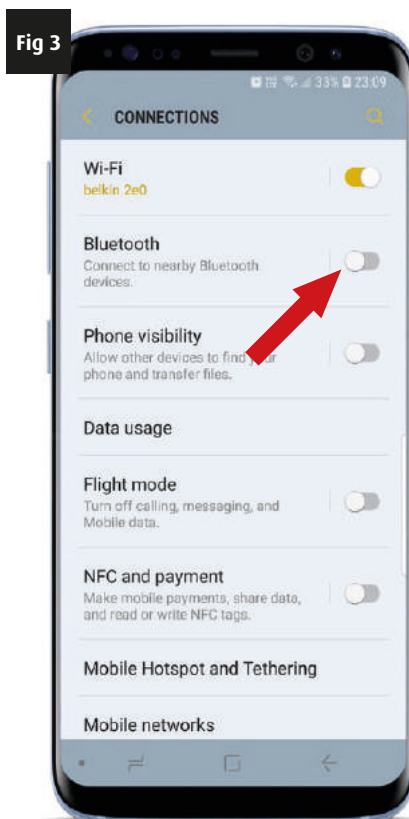
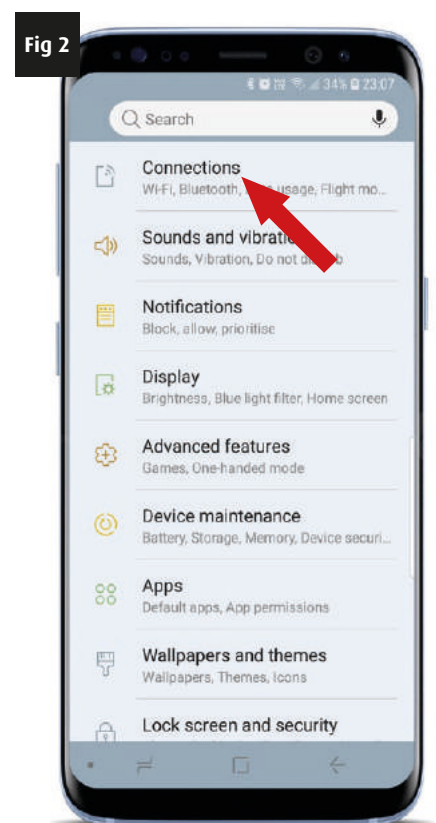

Remember: You may be able to view the complete screen, but you may need to scroll up/down to see all the different items.

App installation and set up - Android

Using the Remote Phone accessory: This is a modified "Android" based phone

Have you purchased the accessory rather than using your own phone, or purchased it as a second "remote" for someone else to use?

If so then you will find the Scatterbird application all downloaded ready for use and the Bluetooth option, time and date already set up for you.

Things to check before running the Scatterbird App on your Android Phone

For the dawn and dusk feature to work, your phone needs to be connected to either your phone network or the internet when you program the profiles.

From the comfort of your home, you can easily set up the profiles, and then later send them to your Scatterbird when in the field. Your Scatterbird MK4 will function 100% without this feature if you are not connected to the internet when programming.

Using the Scatterbird App

Running the Scatterbird App

The look of the Scatterbird App is virtually identical on any phone or smart device. For the purpose of this walk-through demonstration we are using the Scatterbird App on an iPhone. You may notice small differences on your smart device, the primary difference is that you may need to scroll up or down on some pages to see all the information or selections available.

Overview of the Scatterbird App

The following pages highlight the different functions of the Scatterbird App. You will be able to look at these in the comfort of your home, as you can set up programs ready to use remotely away from the main unit. When you are in range of the Scatterbird MK4 you can sync (connect and talk) to the main unit with your smart devices Bluetooth and tell it which program you want it to run.

Weekly Program:

You can set the Scatterbird MK4 to do the same thing everyday of every week.

You can decide how many bangs in each sequence (plus a random feature), the intervals between each cluster of bangs (plus a random feature), time to start in the morning and time to finish in the afternoon or evening. The Scatterbird unit will then continue doing the same pattern everyday, every week.

You also have the option of turning any day off if you want to as well. The more that you vary the banging of a gas gun the better, so you can now have...

Daily Program:

You can set the Scatterbird to a different thing each day of every week.

For example on Monday you could have it banging once every 20 minutes between 8.30am and 5pm. Tuesday you could have it banging a random number of times every 40 minutes between 8am and 9pm at night. Each day can be as different as you want it to be.

You can even turn days completely off if you need to do so for the sake of your local community, perhaps each Sunday (or have it starting that bit later!). The flexibility of the Scatterbird MK4 is second to none.

Fig 1

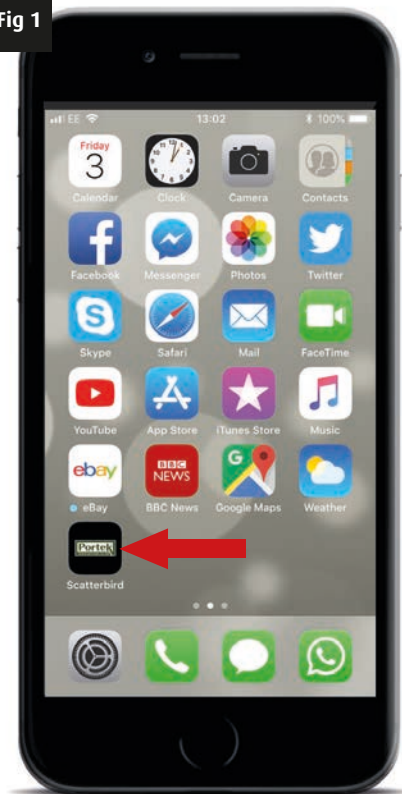

Whether daily routines or weekly you have the options below:

- **Time:** Between midnight and 11.30pm the same day in 30 minute intervals.
- **Number of Bangs:** 0, 1, 2, 3, 4, 5 or Random.
- **Intervals Between Bangs (Minutes):** 10, 20, 30, 40, 50, 60, 70, 80, 90, 100 or Random.
- **Loudness:** Level 1, 2, 3, 4 or 5.

Using the Scatterbird App

PROGRAMMING DETAIL

It may seem daunting, but you will find that the programming of the unit is extremely simple. You can't break it, so play with it in the comfort of your home. Programs (PROFILES) can be changed, completely deleted or names changed, so you will soon discover how easy it is.

To launch the application press the Portek Scatterbird App icon on your phone (Fig 1). There is a quick splash screen while the application loads (Fig 2) and you will then be presented with a starting screen as shown (Fig 3).

When you click on the "NEW PROFILE" button (Fig 3) you will be asked if the application can use your location (Fig 4), this will allow it to know where you are and from that information know when dawn and dusk are. Click allow. You can now start to create a profile for use on your new Scatterbird.

The "NEW PROFILE" screen may all be visible on one screen or you may need to scroll the screen to see the different parts, like the samples shown.

The "NEW PROFILE" screen has two main options. The tab which opens first, highlighted at the top left, is the weekly screen. The alternative is the Daily screen, which can be reached by tapping on the "Daily" tab.

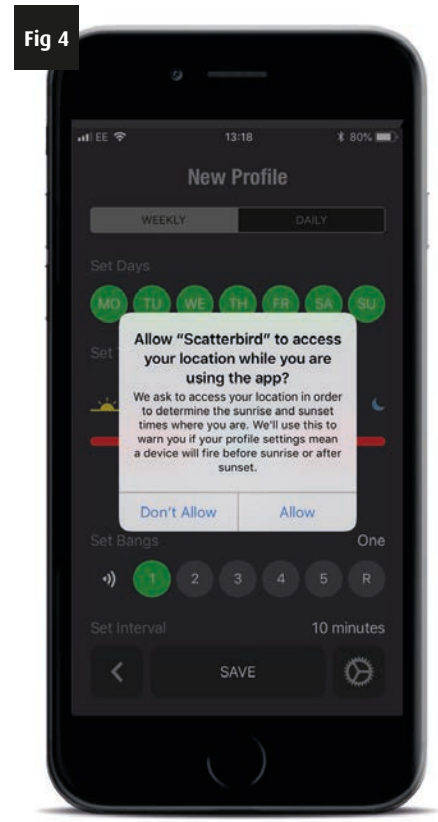
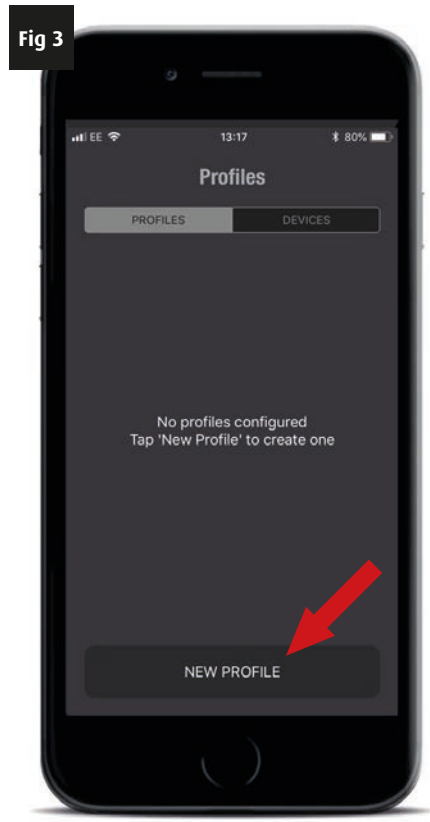

Remember: You may be able to view the complete screen, but you may need to scroll up/down to see all the different items.

Using the Scatterbird App

Both of these tabs look very similar and the options are almost identical, so will be described on the weekly tab first.

THE WEEKLY TAB

This has 5 main things which can be changed:

1. Set Days

Click the days on or off by touching the day. Green is on, red is off (Fig 1 & 2). In the example screens the profile will set the unit off (not banging) on Saturday and Sunday, but on during the other days.

2. Set Time

This is the time during the day that the unit will operate. The start and stop times can be changed by placing your finger on one of the sliders and moving it along (Fig 3 & 4). You will see the start or stop time changing as you do this. You can alter the time in half hourly amounts anytime between midnight and 11.30pm the same day.

Fig 1

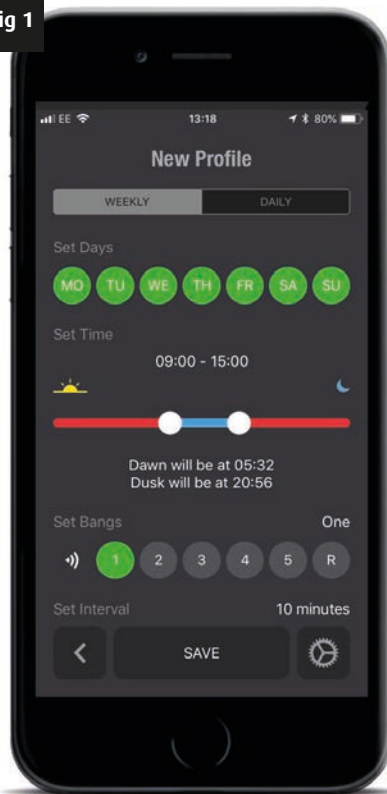

Fig 2

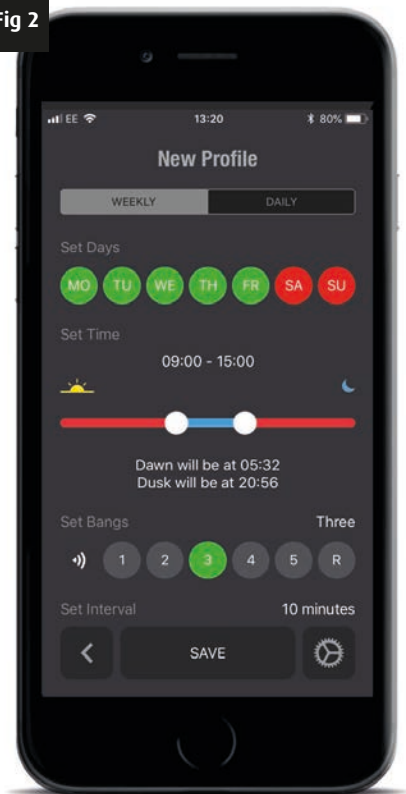

Fig 3

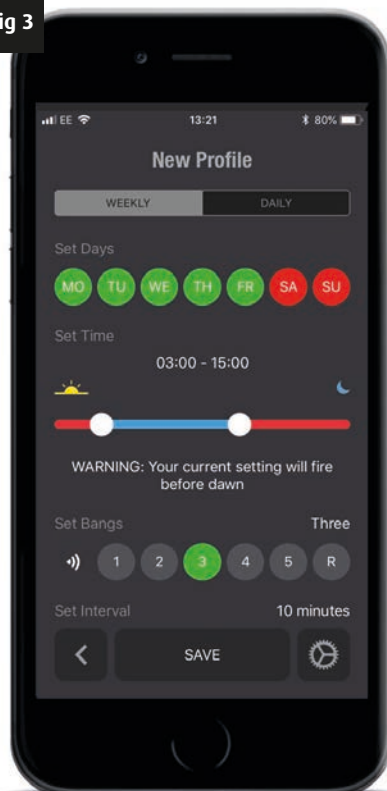
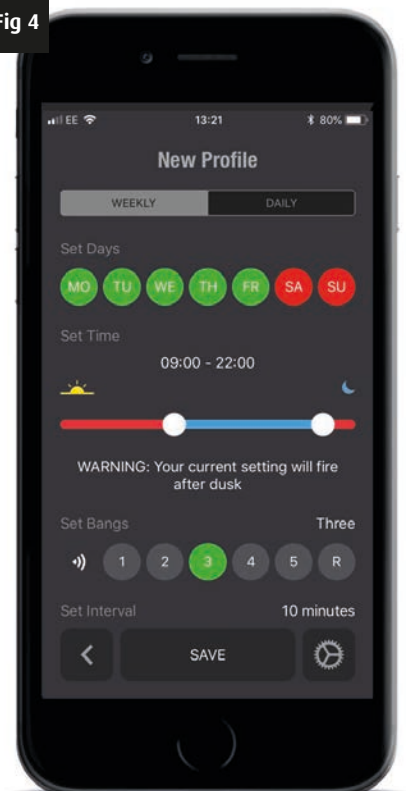

Fig 4



Remember: You may be able to view the complete screen, but you may need to scroll up/down to see all the different items.

Using the Scatterbird App

If you move the slider before when dawn starts or after dusk you will get a warning advising you of this. The unit will still operate the profile.

Fig 5 shows an example of the warnings which may be shown. If you want to disable the warnings you can by clicking on "Settings" icon (Arrowed, Fig 5).

In the settings screen, switch the warnings on or off by touching the button (Fig 6 & 7). Click "DONE" when you are finished to return to the main profiles screen.

Set to show warnings set to not show warnings

Please note that the warnings will only work if your location is known by your phone when you create or edit a Profile. Your location is known by your phone if you are connected to the internet. Some phones will also know your location without being connected by the use of proximity to phone masts.

This updates your position and advises your phone of dawn and dusk setting for your location. If your phone does not have your location you can still set the time for operation, you just will not have the dawn/dusk warnings. If you have disabled the warning by not allowing your location to be known then this feature will not function.

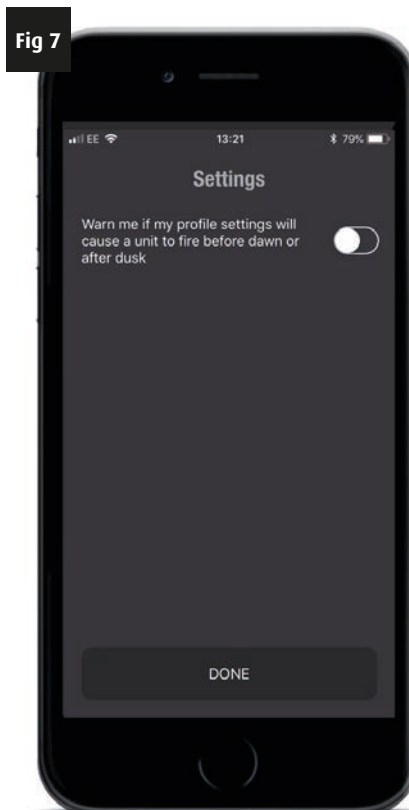
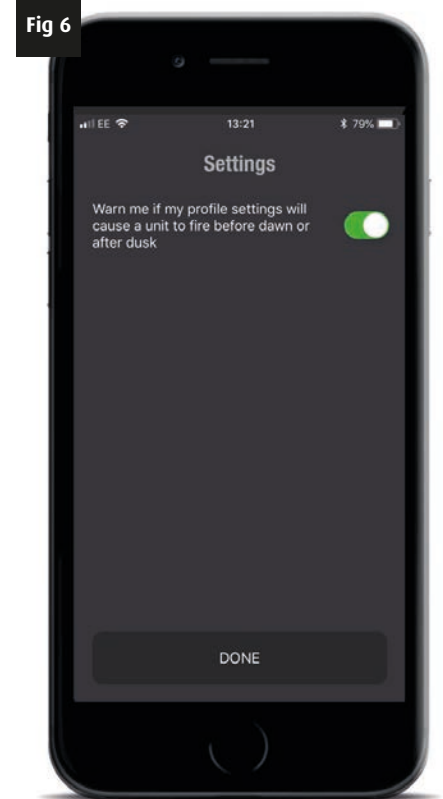
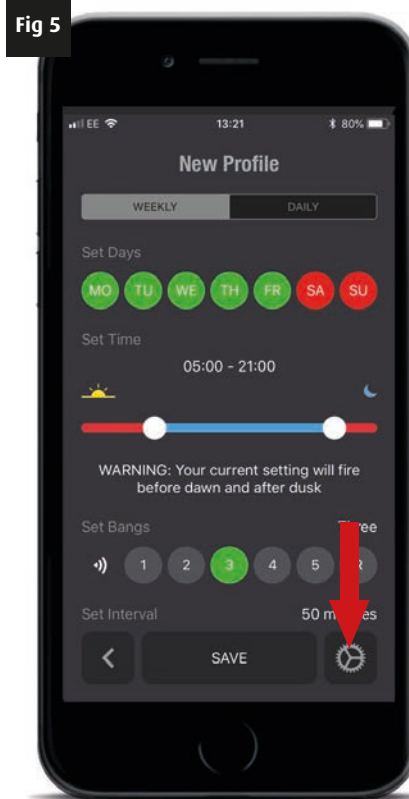

Remember: You may be able to view the complete screen, but you may need to scroll up/down to see all the different items.

Using the Scatterbird App

3. Set Bangs

The Scatterbird MK4 unit will make however many bangs are set in immediate succession (Fig 1). We call this succession of bangs a cluster. You can change the number of bangs between 1 and 5. There is also a random feature, which will select the number of bangs randomly between 1 and 5. Select the number of bangs you want by touching the button desired. It will turn green and the number selected will also be written on the right hand side.

Fig 1

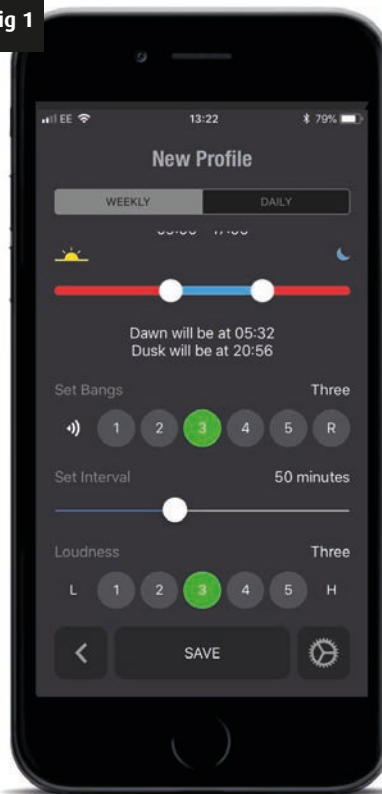
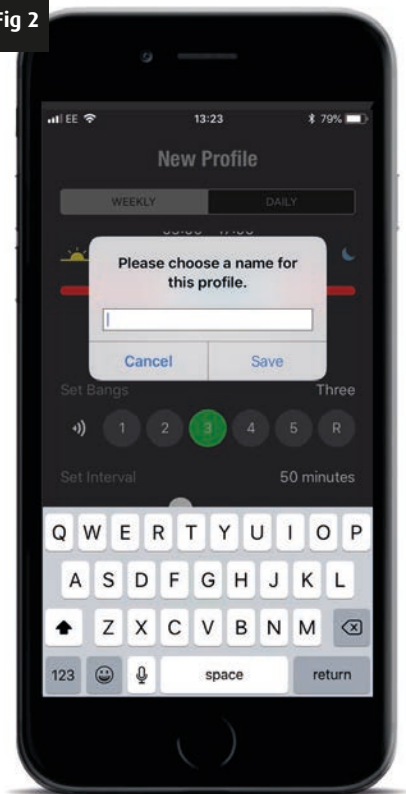

Fig 2



4. Set Interval

The interval between clusters of bangs can be varied by using the slider at the bottom of the profiles page (Fig 1). You may need to scroll your screen up to see this.

Fig 3

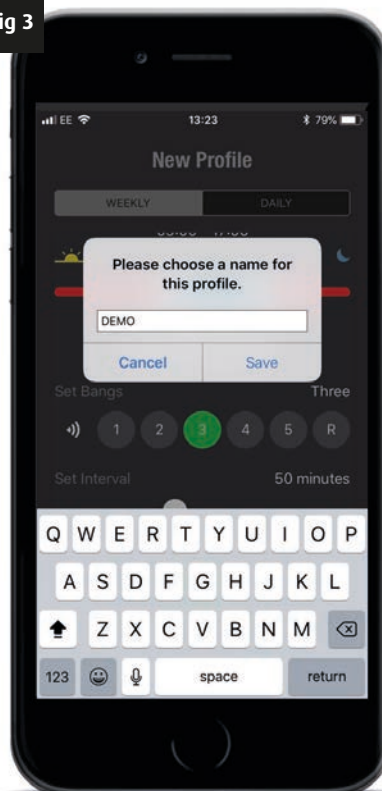
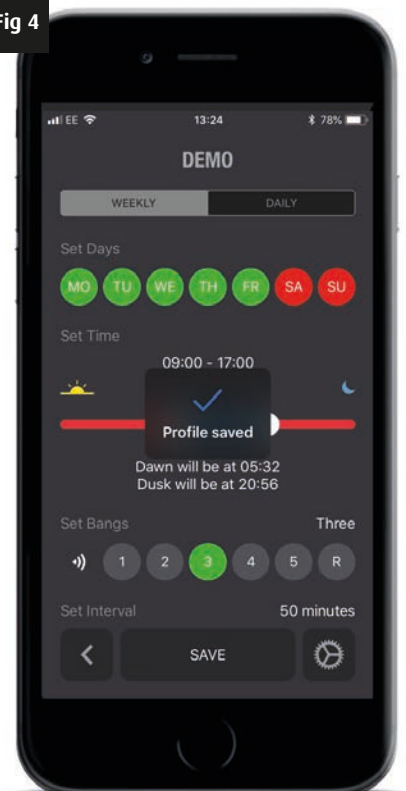

Fig 4



5. Loudness

Here you can adjust the volume of the profile to suit varying conditions (Fig 1). If you have a particular field close to neighbours you may want to reduce the volume in this circumstance. As Scatterbirds get older the residues in the propane gas slowly reduce the size of the jet allowing less gas into the unit. Eventually this reduction is noticeable in the loudness of bang. If the jet is not cleaned through this can even get to misfiring of the unit.

Remember: You may be able to view the complete screen, but you may need to scroll up/down to see all the different items.

Using the Scatterbird App

If you have a unit set at volume 4 (the default setting) and it starts to reduce in noise, you can extend the time temporarily before cleaning the jet by increasing the volume to 5. All this does is allow a little more time for the gas to come through. Eventually of course the jet will need cleaning as part of your maintenance, but it is an option if you need to use it.

When you are happy with the settings you have you need to save the profile by clicking the "SAVE" button at the bottom of the screen (Fig 1, Prev. Page). A screen will come up, allowing you to give a name to your profile (Fig 2, Prev. Page), for this walk-through we have named it "DEMO" (Fig 3, Prev. Page).

Click "SAVE" and you will notice that the profile screen has now been renamed. You can have as many profiles as you want, it can be a good idea to describe the function in the name. You can even include icons if you wish.

If you want to change the name of a profile click on the edit button (Fig 5). This will bring up the following screen (Fig 6), where you can either edit the name or delete the profile completely.

To see all the profiles you have created you only need to press the back arrow (Fig 8).

Fig 5

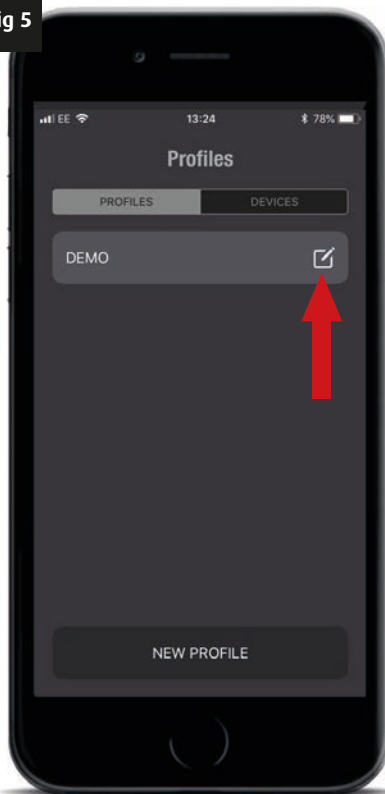

Fig 6

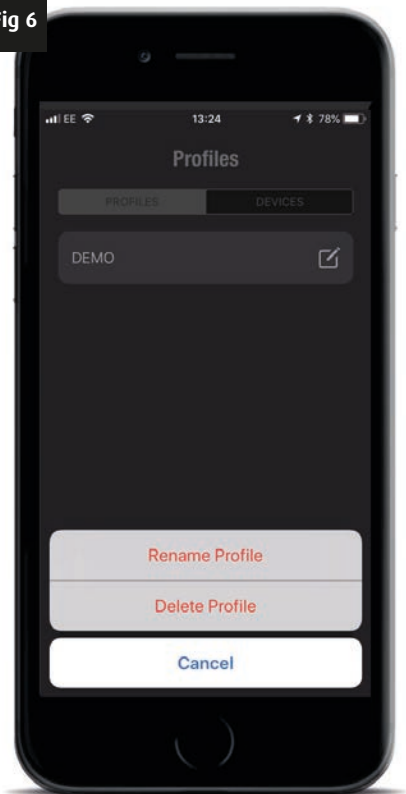

Fig 7

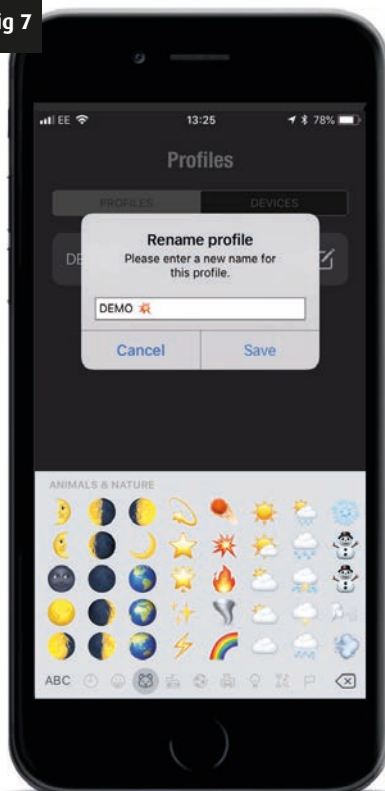
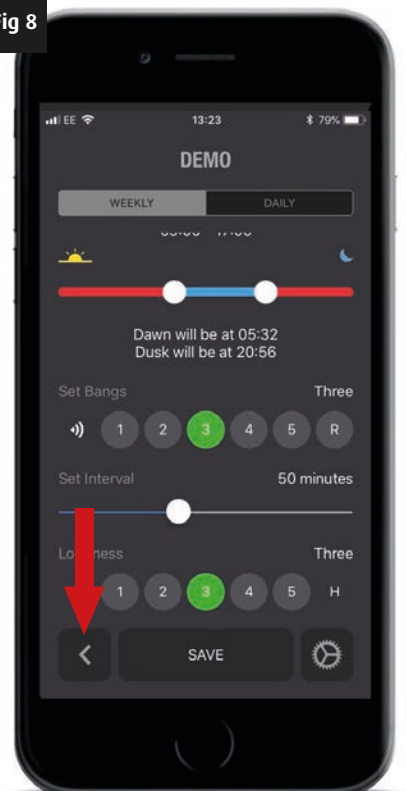

Fig 8



Remember: You may be able to view the complete screen, but you may need to scroll up/down to see all the different items.

Using the Scatterbird App

THE DAILY TAB

To look at the "DAILY TAB" we need to start by creating a new profile. Click the "NEW PROFILE" button at the bottom of the screen (Fig 1). "The "DAILY" programme settings is reached by then clicking the 2nd tab (Fig 2). This performs in almost the same way as the "WEEKLY" tab.

The difference is that you will not see the list of days to switch on and off. This is replaced with individual days, where you can have the Scatterbird MK4 operating or not.

The opening screen will show the first day of the week, Monday. Here the day is switched off, it can be switched on by touching the on/off slider button to show green (Fig 3).

The other features: set time, set bangs, set interval and loudness - all are identical to the descriptions on the "WEEKLY" tab found on the previous pages.

Changes will be made here for Monday. You need to set every day individually. You can scroll to different days by clicking forward or back arrows next to the current day as shown on the right picture (Fig 4).

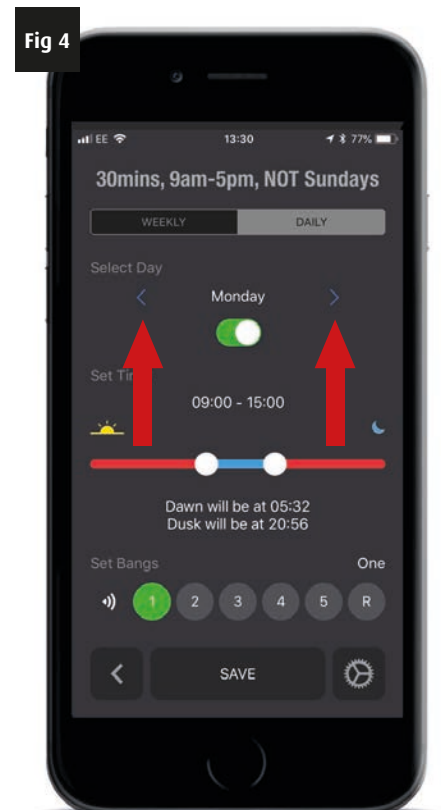
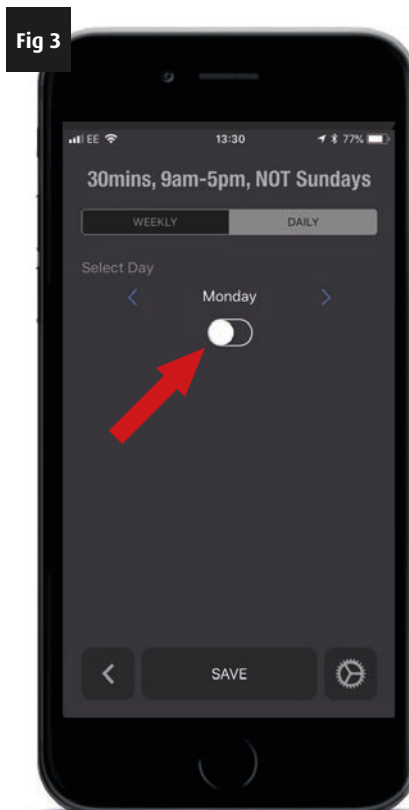
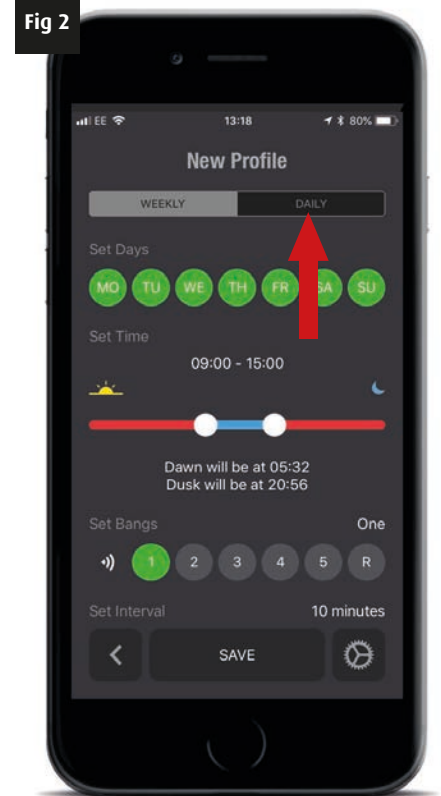
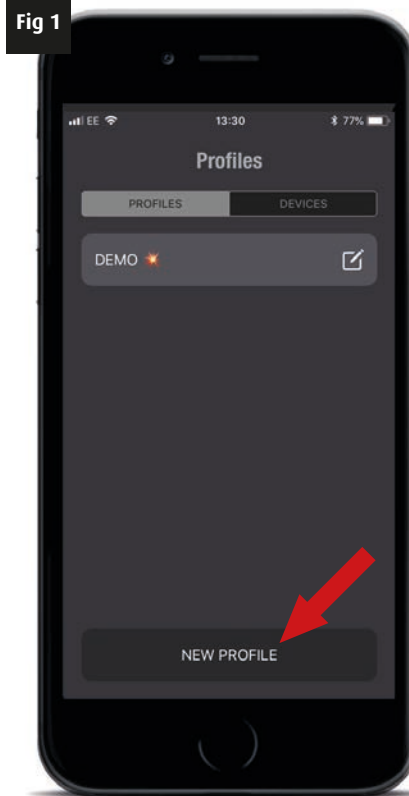

Remember: You may be able to view the complete screen, but you may need to scroll up/down to see all the different items.

Using the Scatterbird App

If you want to set some days on and some days off, you can easily do this. If you want to vary the number of bangs, change the interval times between bangs, loudness, or if you want to set different start or finish times for every day you can easily do this too. With the "DAILY" tab you have 100% flexibility with every setting on every day!

Though the programming will take a few minutes to set up, remember that the unpredictable nature of the bangs day to day helps prevent birds being accustomed to the Scatterbird, making it more effective than any other gas gun available.

When you have completed your settings for each day to what you want to happen, remember to "SAVE" the profile (Fig 5) and to give it a name for future reference.

You can give profiles names which describe exactly what they will do (Fig 6). The example has the interval between clusters, start and finish time during the day and that it is switched off on Sundays, but you could have more or less information as you decide.

If you want to re-edit a profile at any time you can do so by just pressing the name from the list of profiles (Fig 6). You can then edit as you wish, then resave.

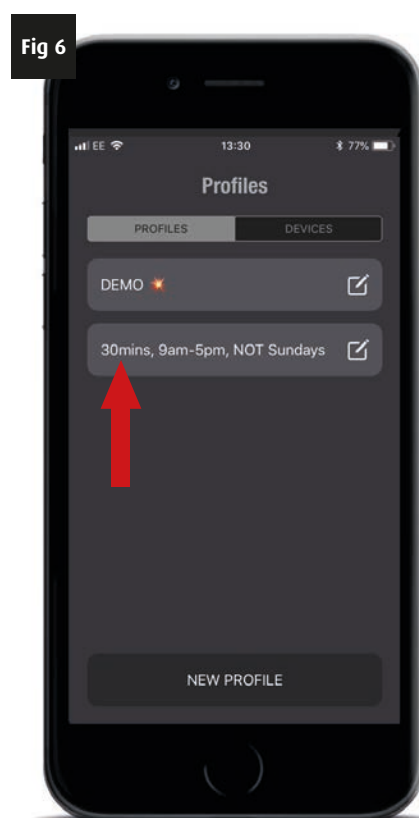
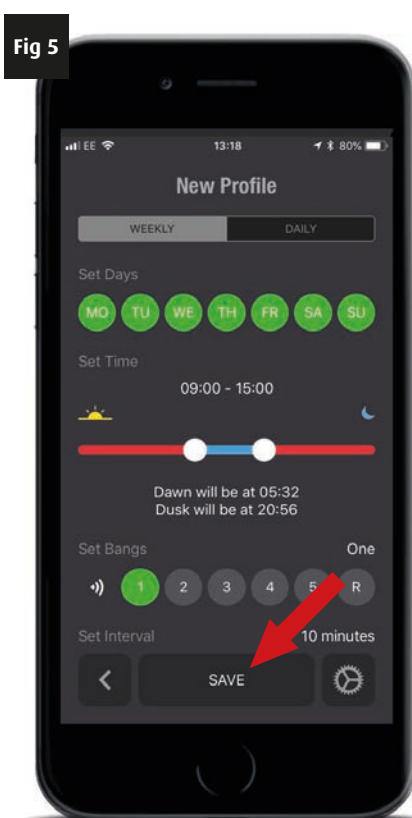

Remember: You may be able to view the complete screen, but you may need to scroll up/down to see all the different items.

Using the Scatterbird App

Fig 1



Fig 2

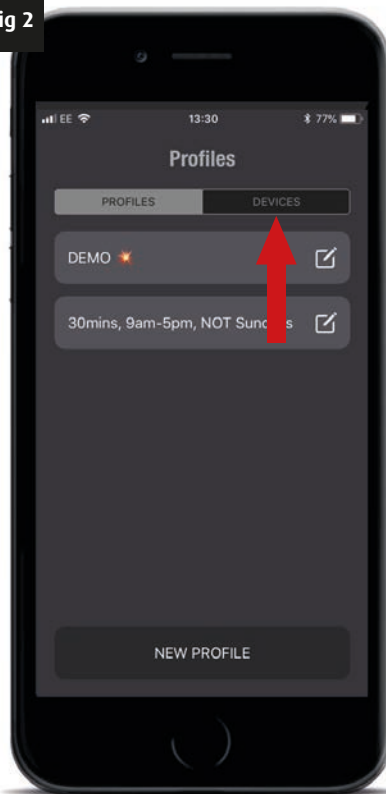
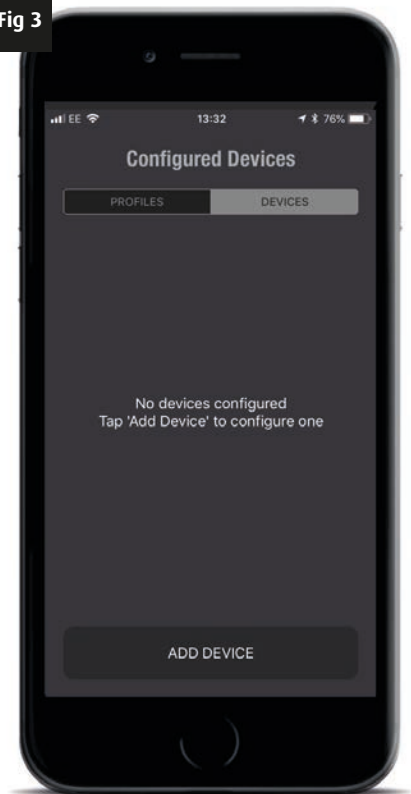

Fig 3



CONNECTING TO YOUR SCATTERBIRD MK4

Now that you have at least one or more profiles, it is time to synchronize one to your Scatterbird (transfer it from your phone into a Scatterbird unit).

The Scatterbird MK4 and your smart phone connect by using Bluetooth. The range of this varies phone to phone, but is typically 15 - 20m. This function must be switched on if it is not already.

Check to see if you have the Bluetooth symbol (Circled, Fig 1) visible at the top of your phones screen.

If you are unable to see or it is not displayed, you will need to switch Bluetooth connections on, as described on page 11 for iPhones and page 17 for Android phones.

Connect your Scatterbird MK4 to a power source, either an external or internal 12V battery. Once the battery is connected, you will see a small blue intermittent flash from an LED located under the silver information sticker on the upper orange plastic back plate. This LED indicates the unit has power and Bluetooth connectivity is available. It is effectively "looking for something to talk to" while it is flashing.

After a few seconds this will stop, but repeat again after about a minute. During one of these "looking" periods your phone will recognise that there is a Scatterbird it can connect to.

From your profiles page within the application, click on the "DEVICES" tab (Fig 2).

If it is the first time the application has been run or have tried to connect to your Scatterbird it will say "No Devices Configured" (Fig 3).

Click on the "ADD DEVICE" button at the bottom of the screen (Fig 3).

Using the Scatterbird App

Your phone will begin to scan for near by devices and before long "Scatterbird" should appear. Depending on your phone this may be almost instantaneous or take a minute or so. As a hint click on the "ADD DEVICE" straight after putting power to the Scatterbird. This way the Scatterbird is immediately looking for something to talk to.

By clicking on the "Scatterbird" listed (Fig 5), your smart phone will automatically try to connect to the unit. Depending on the programme and the speed of your phone this may take a couple of minutes (Fig 6).

Once it has connected to your Scatterbird, the App will ask you to "Pair" it with your phone (Fig 7).

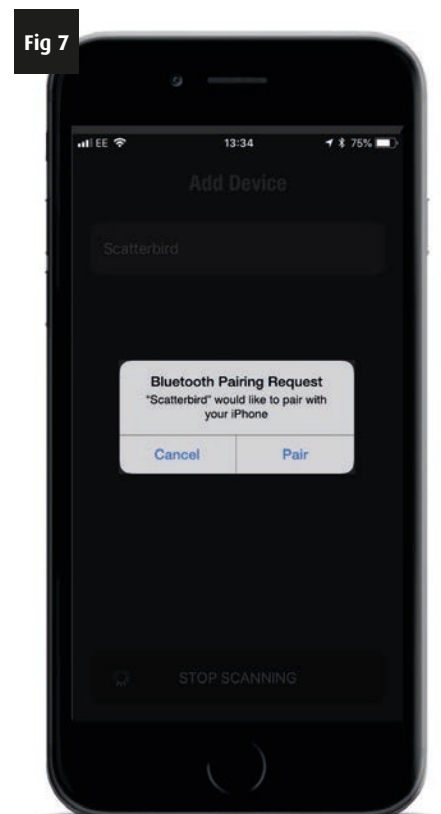
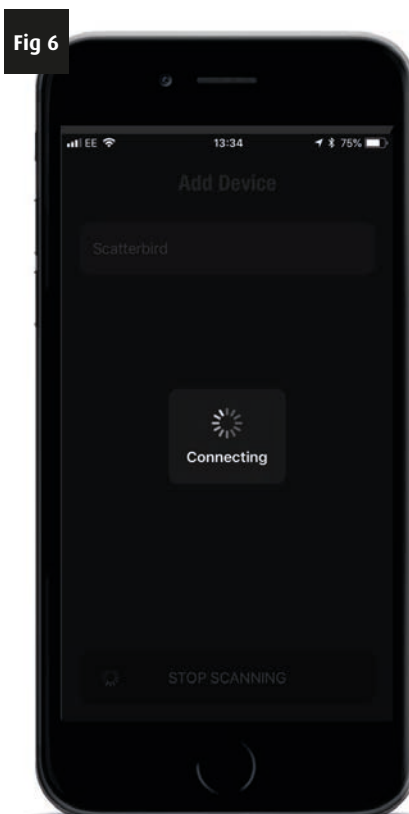
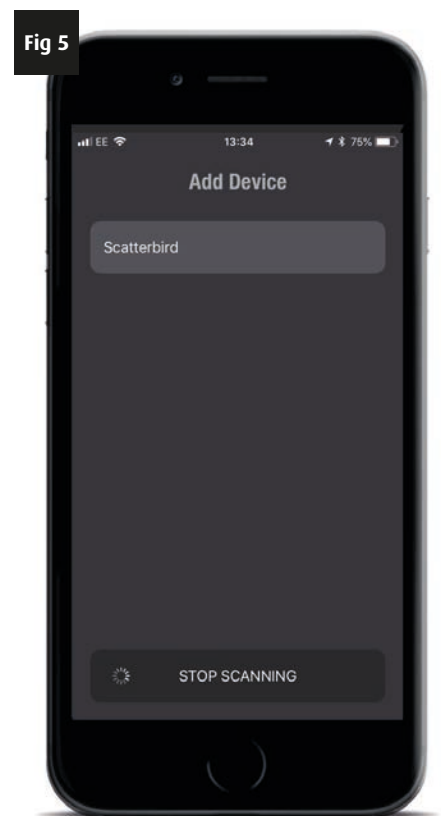

Remember: You may be able to view the complete screen, but you may need to scroll up/down to see all the different items.

Using the Scatterbird App

Every Scatterbird MK4 unit leaves the factory with the connection number (pin) set to '0000' (four zeroes). Please key this in when prompted and click the "CONNECT" button (Fig 1).

After a short while you see a green Bluetooth symbol appear next to your Scatterbird device (Fig 2). This lets you know that your phone and Scatterbird are now connected. You will also notice that the connection status blue LED on the Bluetooth receiver panel is now lit. This will happen every time your Scatterbird is connected to a phone.

Click on the "Scatterbird" and you will be shown the units battery level as well as details about the last profile used and the last time the Scatterbird was synchronized (Fig 3). If this is the first time connecting to your Scatterbird then there will be no information listed, only battery level.

Select a profile you wish to use by clicking on the "PROFILE" button at the bottom of your screen (Fig 3). You will see all your saved profiles listed. Choose the profile you want to load on to the Scatterbird (Fig 4).

Fig 1

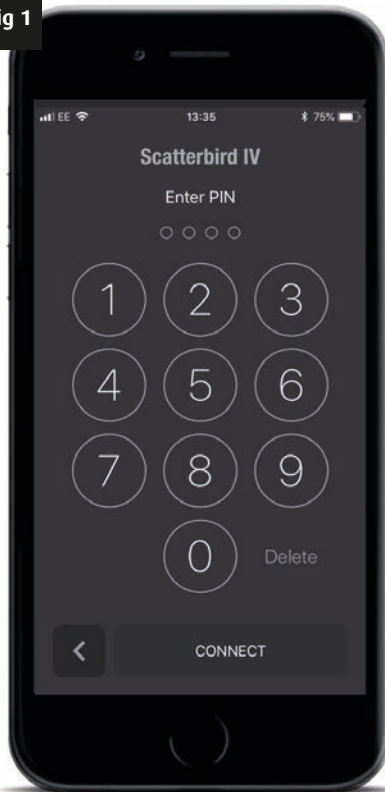

Fig 2



Fig 3

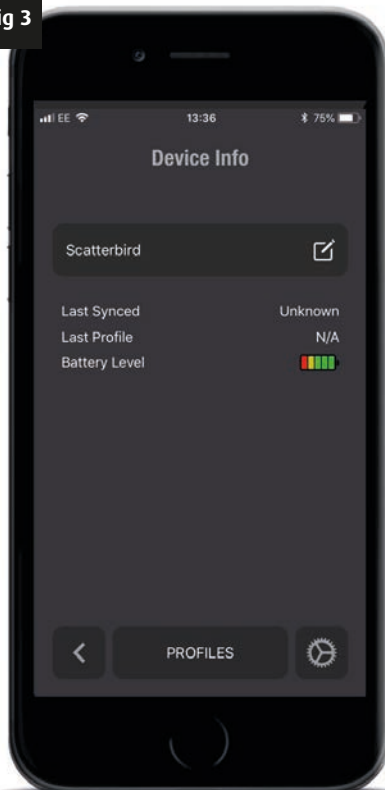
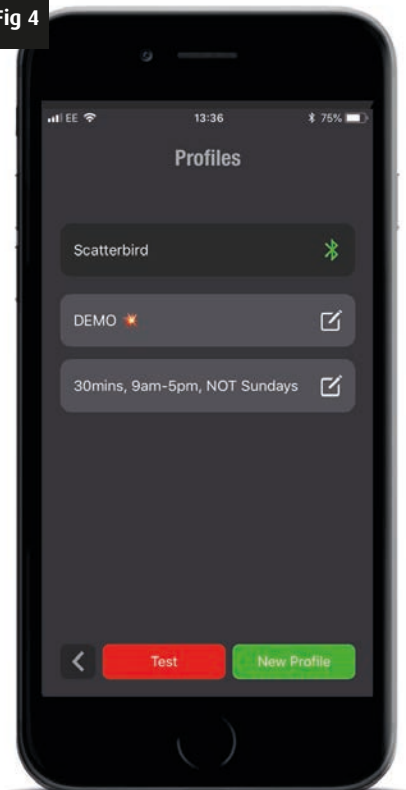

Fig 4



Remember: You may be able to view the complete screen, but you may need to scroll up/down to see all the different items.

Using the Scatterbird App

You now need to synchronize the profile to your Scatterbird unit by pressing the "SYNC" button (Fig 5). What this does is send the profile to the Scatterbird. You will see the message "Syncing" while the profile is transferred to the Scatterbird.

Depending on the programme and the speed of your phone this may take a minute or so. After the synchronization is complete you will be given the option to "EXIT" or "TEST" (Fig 6).

Exiting will finish the setup with the profile you have chosen and you can leave the Scatterbird to run.

If you want to test it to make sure it fires OK then press the "TEST" button (Fig 6) and then confirm the test fire (Fig 7).

You will be shown a countdown screen, which counts from 10 to 0 (Fig 8). When the counter hits zero the Scatterbird should go bang once.

Make sure you (and anyone in the vicinity) have suitable ear protection on when test firing and stand behind the gun as it is quieter than in front!

Until the countdown reaches 5 you can cancel the test fire. For safety, when gas is about to enter the Scatterbirds combustion chamber, you cannot cancel the countdown (Fig 9).

Fig 5

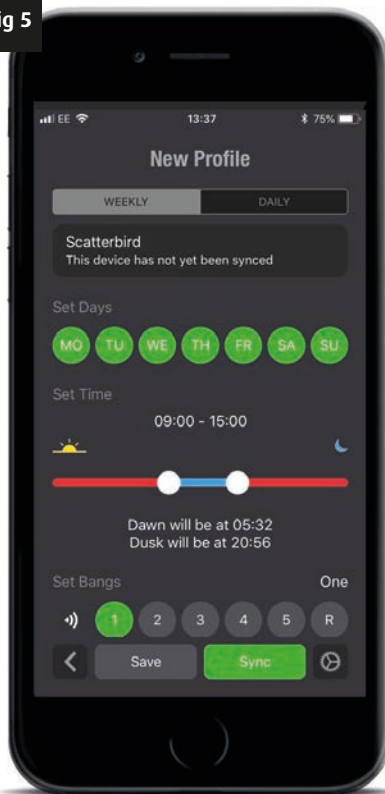

Fig 6

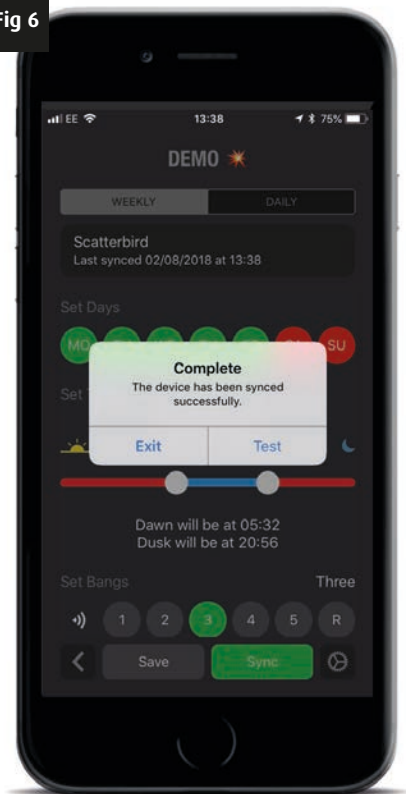

Fig 7

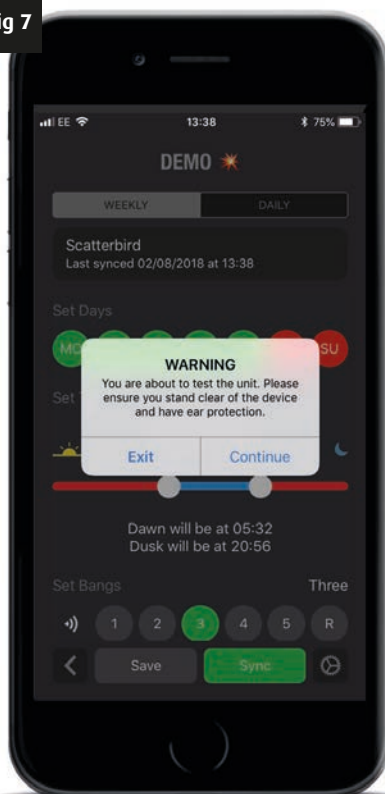

Fig 8



Remember: You may be able to view the complete screen, but you may need to scroll up/down to see all the different items.

Using the Scatterbird App

When the counter is less than 5 you will hear a click, which is the solenoid valve opening. You will hear the gas filling the chamber. After another click, the gas being turned off by the solenoid valve, the spark generator will create a series of sparks which jump across the spark plug. These ignite the gas mixture creating the bang.

Your Scatterbird MK4 is now fully programmed and tested. It can now be left to continue with the profile you have loaded it with until you wish to change the profile or the gas and/or battery need to be replenished.

Multiple Scatterbirds

You will only need to scan for and "Pair" with any Scatterbird unit once. After that your phone will automatically see the Scatterbird in Bluetooth range and connect automatically. The range of this varies phone to phone, but is typically 15 - 20m. You may find some phones have a greater range.

When you are in range, you will see the Bluetooth symbol next to the listed Scatterbird turn from red to green (Fig 11). The phone and Scatterbird have paired automatically and you can check the battery or change the profile that the Scatterbird will run as described previously (Fig 12), you can do this by simply tapping the Scatterbird in the list previously.

Fig 9



Fig 10

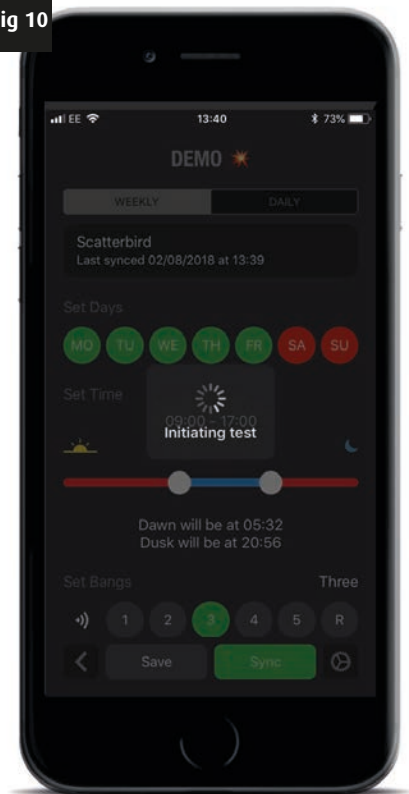

Fig 11

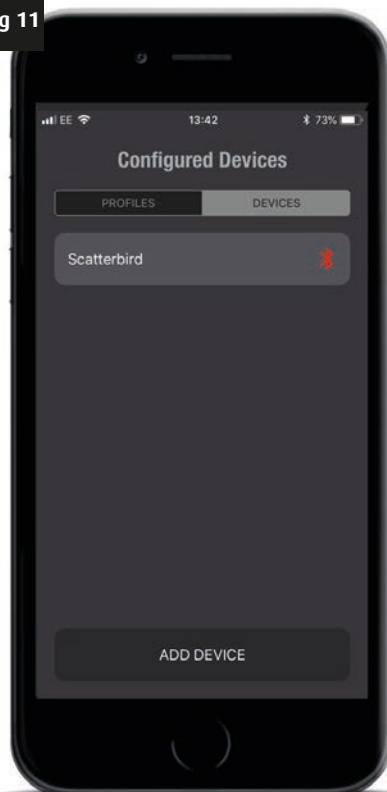
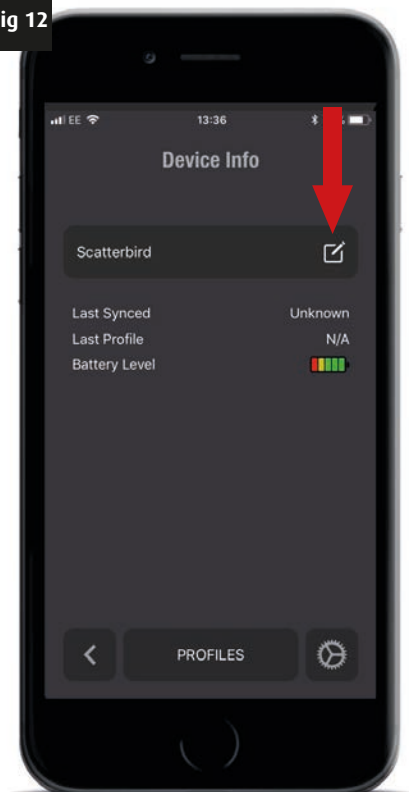

Fig 12



Remember: You may be able to view the complete screen, but you may need to scroll up/down to see all the different items.

Using the Scatterbird App

Note: If you want to add more than one Scatterbird to your phone App then you can. You can link to multiple Scatterbird units, iPhone users will not need to alter the name of the units, you can leave them all as "Scatterbird" is you wish.

Some Android users may need to give each Scatterbird they connect to a unique name before it will allow them to find another unit. To change the name of a Scatterbird, click the "Edit" button (Arrowed, Fig 12) and update the name of each Scatterbird as required (Fig 13). As you add more Scatterbirds to your phone your list will get longer and longer. Note that there is a limit of how many Scatterbirds your phone can have in its list. Many will be able to hold hundreds in memory, but some may only be able to have as low as 12, for example, all depending on the make and model of the phone.

Fig 13

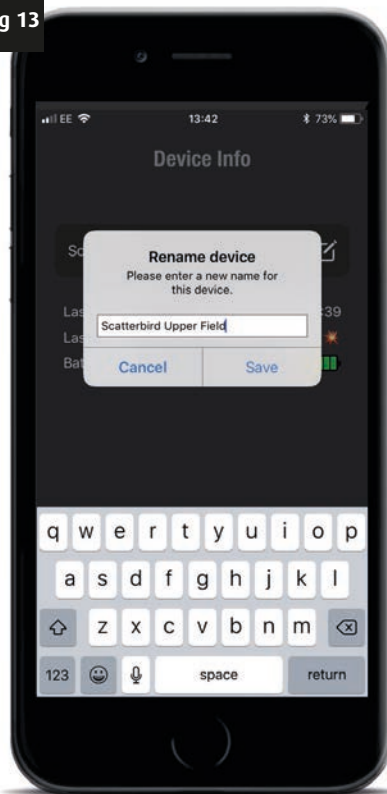
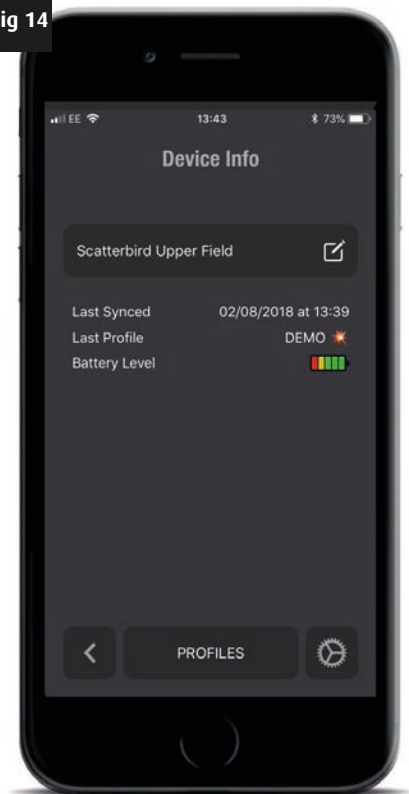

Fig 14



Remember: You may be able to view the complete screen, but you may need to scroll up/down to see all the different items.

Additional Notes:

Daylight Saving/British Summer Time

Please note that your Scatterbird MK4 unit will not automatically update for the hour change. However your phone will, so all you need to do is re-synchronize your Scatterbird when convenient.

Changing the Battery

When you change the battery on your Scatterbird MK4 you will need to re-synchronize (send profiles to the main unit). This enables you to check profiles you want and to do a quick test fire to make sure everything is working correctly. It will also allow you to check the battery level of the new battery.

Additional App features

Changing the Pin Code

Every Scatterbird MK4 leaves the factory with the connection pin code '0000' (four zeroes) and this is what you will have used when pairing your Scatterbird for the first time. We suggest that once paired, for security & safety and to stop anyone else from controlling your Scatterbird that you change the pin code.

In the unfortunate event that you have a Scatterbird stolen, the unit will not work with the '0000' pin code, so is of no value to anyone else. This feature is a good deterrent against theft. If you have a number of units on your site, you might want to set them all to new pin codes. These can all be the same number if you wish, but would be unknown to anyone unauthorised by you.

To change the pin code, click the "Settings" icon (Fig 1). If for any reason you need to forget the device, perhaps because you sell it or you change your phone, you have the option to do so (Fig 2). If you do this by mistake you can always search for it as you did the first time and pair it again using your current pin. To change the pin number click on the "Change Pin" option (Fig 2) and follow the on screen prompts, first entering your current pin (Fig 3) (if it's the first time you have changed since initial setup, this will be '0000'), then entering a new 4 digit pin (Fig 4).

Fig 1

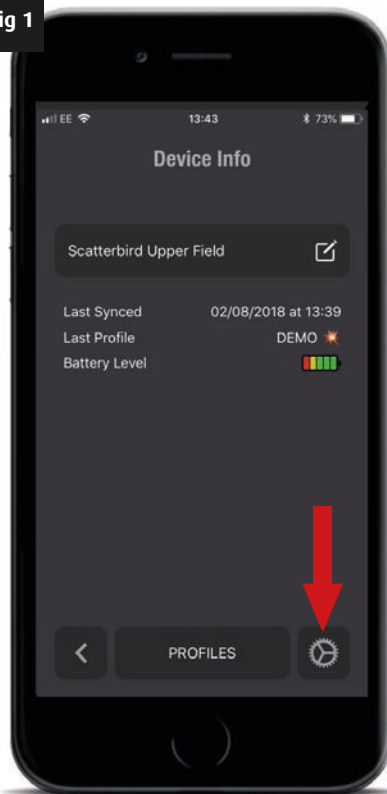

Fig 2

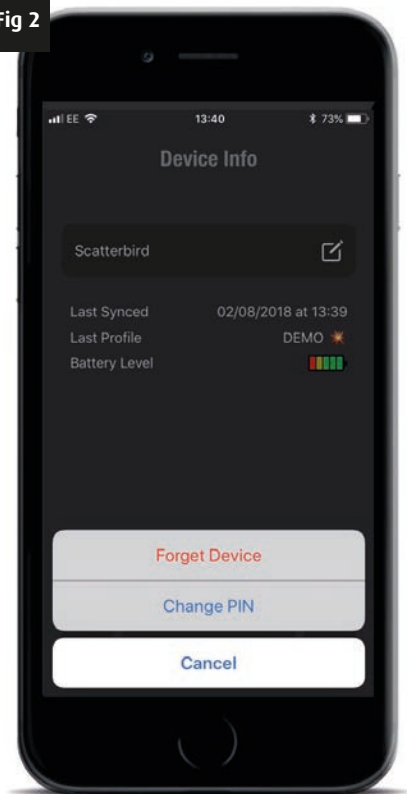

Fig 3

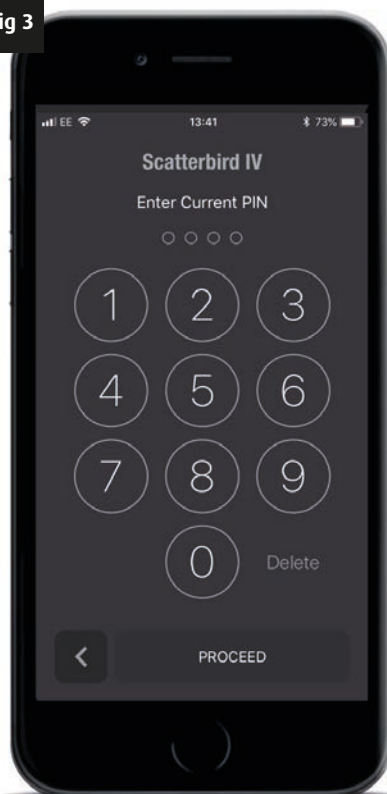
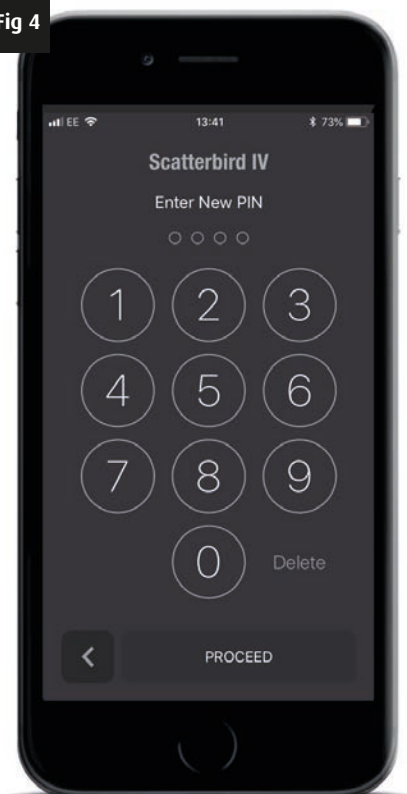

Fig 4



Remember: You may be able to view the complete screen, but you may need to scroll up/down to see all the different items.

Additional App features

You will be asked to confirm the new pin by entering it for a second time (Fig 5).

If you enter a different or incorrect number to the first it will ask you to enter the new pin again.

When you have completed these steps you will see a message confirming the pin has been successfully changed (Fig 6).

Note: You will need to let any additional users on site know the new pin code or they will not be able to connect to the Scatterbird should they need to.

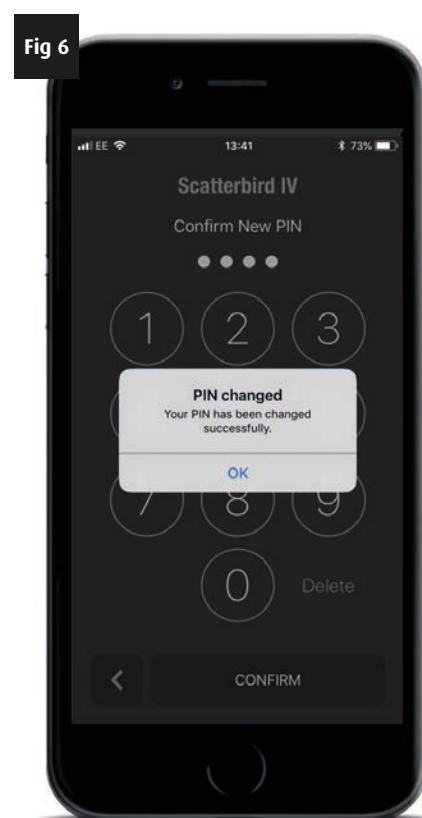
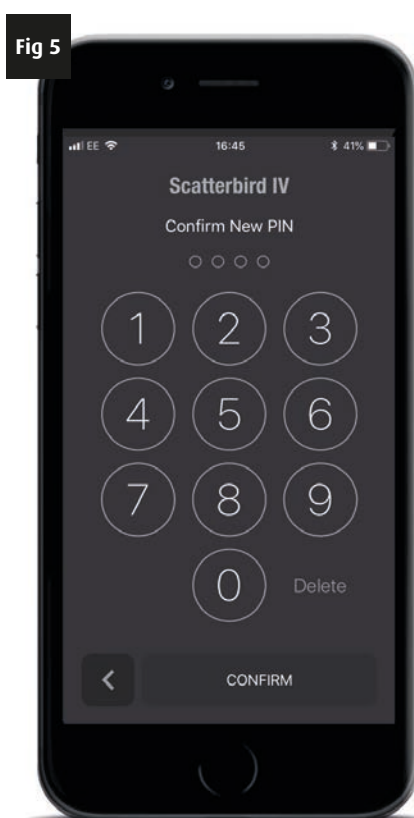

Remember: You may be able to view the complete screen, but you may need to scroll up/down to see all the different items.

Multiple Phones

You can have as many phones as you want that can connect to a Scatterbird, but only one can connect at a time. So farm workers can have phones programmed to enable them to test and change programs as desired. Note that each phone will need to be paired initially to each Scatterbird.

It is a good idea to set all the profiles and their names in each phone the same so that everyone is working with the same possible profiles. That way there is no confusion.

When you connect to a Scatterbird you will see three pieces of information, the "last synced", which normally would give you the date the Scatterbird was last synced; "last profile", giving the name of the last profile that was synced, and battery level. To save confusion the first two of these, last synced and last profile, will only give results if you are looking at the last phone that was used to sync the Scatterbird.

If another phone was used to put the last profile in then this will not show up. What is useful, and will be shown regardless of which phone was used last time, is the battery level.

It is worth remembering that if you happen to have more than one of the phones that have been connected previously to a Scatterbird then one of them will automatically connect to the Scatterbird. If you approach a Scatterbird with a fellow worker with such a phone and try to connect with your phone then it will not connect if the other has connected first!

If you want to connect with one phone and not another then you can either close the App on the one phone or disable the Bluetooth function. This way there is only one phone that can connect to the Scatterbird unit though there are two in the immediate vicinity.

Troubleshooting

If you are having trouble with your Scatterbird MK4 this troubleshooting section will help you determine the problem and remedy any issues to get your Gas Gun up and running again.



Most problems can be tracked down to:

1. Hose damage
2. Blocked barrel
3. Battery condition
4. Solenoid valve
5. Spark generator
6. Gas delivery
7. Blocked jet
8. Spark plug gap
9. Corroded connections

Guidelines in this publication will help you to troubleshoot these issues.



Safety Note:

Before testing your Scatterbird MK4, always turn off and disconnect the gas supply and make sure all residual gas has been expelled from the barrel. If you intend to test fire in the yard, remove the barrel first to avoid a loud bang.

Troubleshooting

The Scatterbird MK4 is simple in its operation. It needs the gas and air in the correct proportions in the stainless steel explosion chamber, followed by a spark to ignite. Trouble shooting is a process of checking that these are correct.

Just as with any mechanical device, it's best to eliminate simple problems before digging further into the technical details - carry out these simple checks first:

1. **Hose damage:** Check the gas hose for damage and replace if needed as vermin do damage hoses through chewing.
2. **Blocked barrel:** Look for foreign material such as a bird's nest or dead vermin in the barrel which are commonly found. Remove obstruction and clean barrel as required.
3. **Battery condition:** Ensure your battery is fully charged and delivering 12 volts. Old tractor batteries lose their charge very quickly; a deep cycle leisure battery (caravan battery) is ideal. You can check that the voltage level is correct within the Scatterbird App. When it pairs with the Scatterbird unit you will get a battery reading.
4. **Solenoid valve:** With the gas disconnected, do a test fire from the Scatterbird App. Check that you can hear a "clunk" of the solenoid valve (Photo 1) opening and about 3 seconds later another "clunk" as it closes. If this can be heard then the solenoid is almost definitely OK. Check with the gas now reconnected. Can you hear the gas rushing in when the solenoid opens? If so then the solenoid is OK.

If it is too low the electronics will automatically stop the unit from opening the solenoid or starting the spark generator (the App will still show as if it is firing).

Remember that the unit will go bang if it has gas and ignition, so always have ear defenders on in preparation for this. If you cannot hear the solenoid valve "clunking" then check that the wires to it are in good condition and the terminals are clean and free from corrosion. If after examination the solenoid is still not working properly then replace it with a new one.

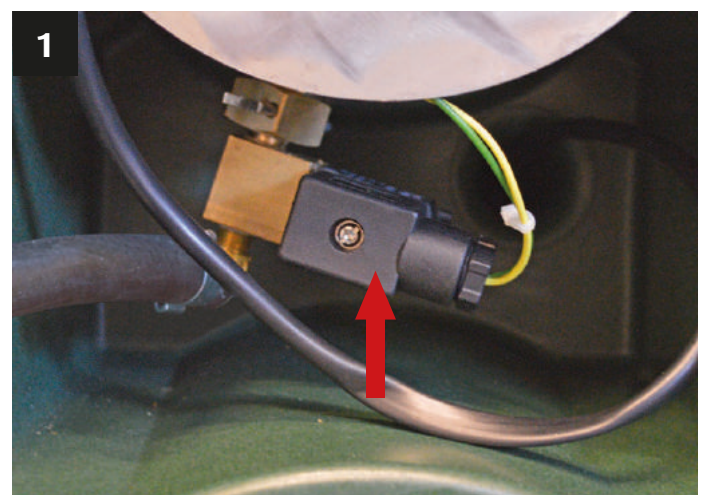

Troubleshooting

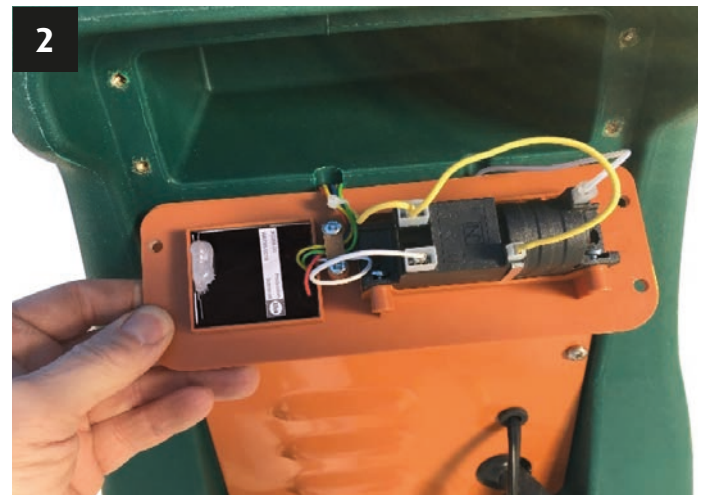
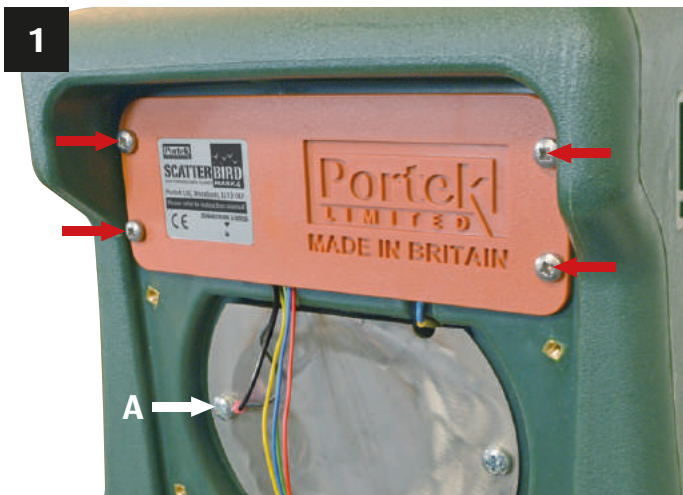

5. **Spark generator:** If the solenoid is OK but the unit is not firing, then it may be that the spark is not being created, or if it is being created it isn't getting to the spark plug to create ignition. With the gas disconnected listen for the two "clunks" of the solenoid. After these you should hear a series of quieter "clicks". If you cannot hear these, then check the wiring to the spark generator, which is attached to the plastic panel on the back of the Scatterbird MK4.

Check that the wires are all in good condition and clean the contacts where they attach to the spark generator (Photo 2) and to the earth point on the back of the barrel (Photo 1, A). The above picture shows the wires connected to a black spark generator. If the unit has a different spark generator then the wiring will either be identical to the above or there may only be 3 connections rather than 4. If there are three then the yellow extra wire which piggy backs from the other one is not needed.

If the unit does not work after cleaning and checking wires than replace the spark generator. If it is replaced with a unit that has different wiring then adapt as necessary. If the new one only has the three connections then ensure that the piggy back wire is taped with electrical tape to ensure it does not short anywhere.

6. **Gas delivery:** If the solenoid and spark generator are both working, then either the spark is not getting to the gas mixture or the gas mixture is incorrect. To check for problems with gas delivery, check the bottle is turned on and contains gas. Try to avoid completely emptying the bottle as it contains residues which can block jets and regulators.

Next, check that the correct regulator is fitted. Use only a One Bar Regulator. If the correct one is fitted, check the connections for damage or loose fitting. Replace or tighten as necessary. When changing the regulator make sure it does not come into contact with the ground as soil particles can block or damage the unit.

Troubleshooting

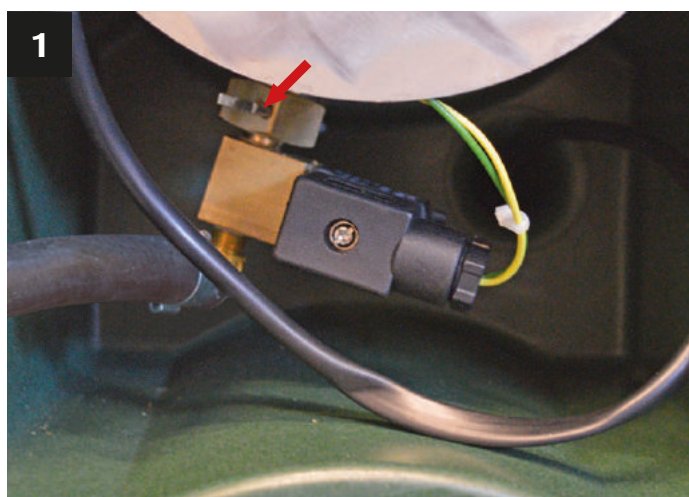

7. **Cleaning the gas jet:** If the unit goes bang but is erratic (perhaps banging 3 out of the 4 times or 2 out of 5 for instance) then this is most likely due to insufficient gas being delivered each time and the gas jet could be partially blocked.

In the UK we have propane which has residues in it. Over time these residues build up in the jet and may need cleaning. To do this remove the split pin that holds the two-part jet together (Photo 1). This will allow the inner jet, solenoid and gas hose to be removed (Photo 2).

Unscrew the jet from the solenoid body (Photo 3). After removal, run a 1mm drill bit through the jet slowly by hand (Photo 4). Clean the jet thoroughly to ensure there is no residue, remaining swarf or contaminants which can get into the solenoid valve or block the jet. Reassemble the jet into the unit. Check to see if the Scatterbird MK4 is now working correctly.

Troubleshooting

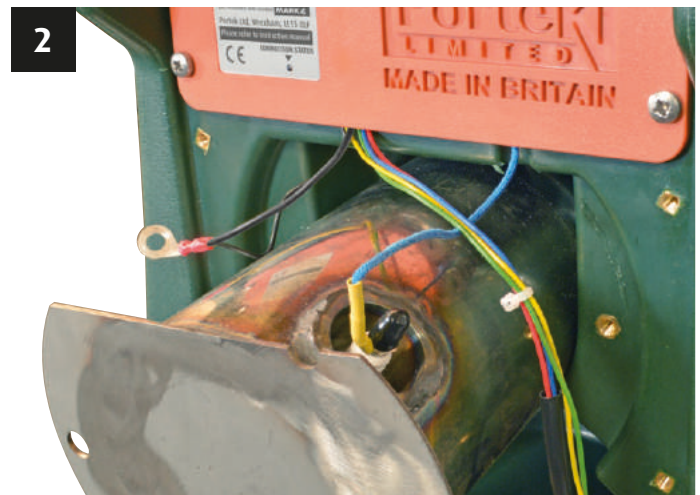
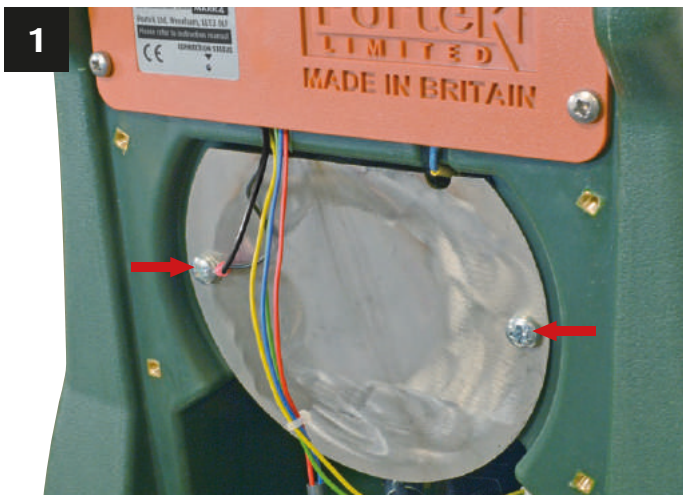

8. **Spark plug:** If the unit does not bang, then it could be that the spark is not igniting the gas. Check the High Tension (HT) lead from the spark generator is in good condition. To gain access to the spark plug the metal barrel needs to be partly removed from the main housing.

First remove the plastic barrel by undoing the retaining screws. The stainless steel section of the barrel is held in place by two screws inside the back plate of the unit (Photo 1). Remove the screws and slide the barrel back about 50 - 75mm, sufficiently enough to see the spark plug end (Photo 2).

As the barrel is partly removed it is good practice to check the spark plug as well as the HT lead wire is OK. Check that the spark plug is correct (NGK BPR6ES or equivalent).

Check also that the spark plug gap is correct, it should be about 3 - 4mm (the thickness of a £1 coin). If the gap is too small it will not ignite the gas. Replace the spark plug or HT lead as necessary and put the unit back together making sure that the connections are tight.

Carefully check that no wires are trapped or kinked during reassembly. The barrel can be pushed back in, or assisted with a soft mallet. Make sure the stainless steel tube is lined up with the opening at the front of the Scatterbird unit before pushing back through. Once in place secure it into position with the two holding screws and reattach the plastic sounding barrel.



Troubleshooting

9. Make sure all the contacts are clean and free from corrosion:

- **Corroded earth:** Remove the back plate and unscrew the earth wires. Clean the connectors and the earth point with emery cloth and reassemble, using Vaseline (petroleum jelly) to protect against future corrosion.
- **Spark plug maintenance:** Remove the rubber cap and unscrew the plug lead followed by the spark plug. Clean the thread, reset the gap using a £1 coin and reassemble making sure you replace the rubber cap.
- **Spark generator contacts:** Take the spade terminals off the spark generator, clean the contacts, and replace using petroleum jelly to protect if needed.

This troubleshooting guide should solve the most common problems you might have with the Scatterbird MK4.

If it still does not fire after these checks, then get in touch with your local dealer or Portek for further information, parts or technical assistance.

Portek will also repair or service your Scatterbird MK4 if required.

IF YOU HAVE WORKED THROUGH THE INSTRUCTIONS & THE TROUBLE SHOOTING GUIDE AND YOU ARE STILL HAVING PROBLEMS THEN CHECKOUT OUR VIDEO AT:

WWW.SCATTERBIRD.CO.UK

IF YOU CONTINUE TO HAVE PROBLEMS WITH YOUR SCATTERBIRD MK4, THEN PLEASE CALL OUR DEDICATED HELPLINE ON:

01234 889 460

Wiring Diagram

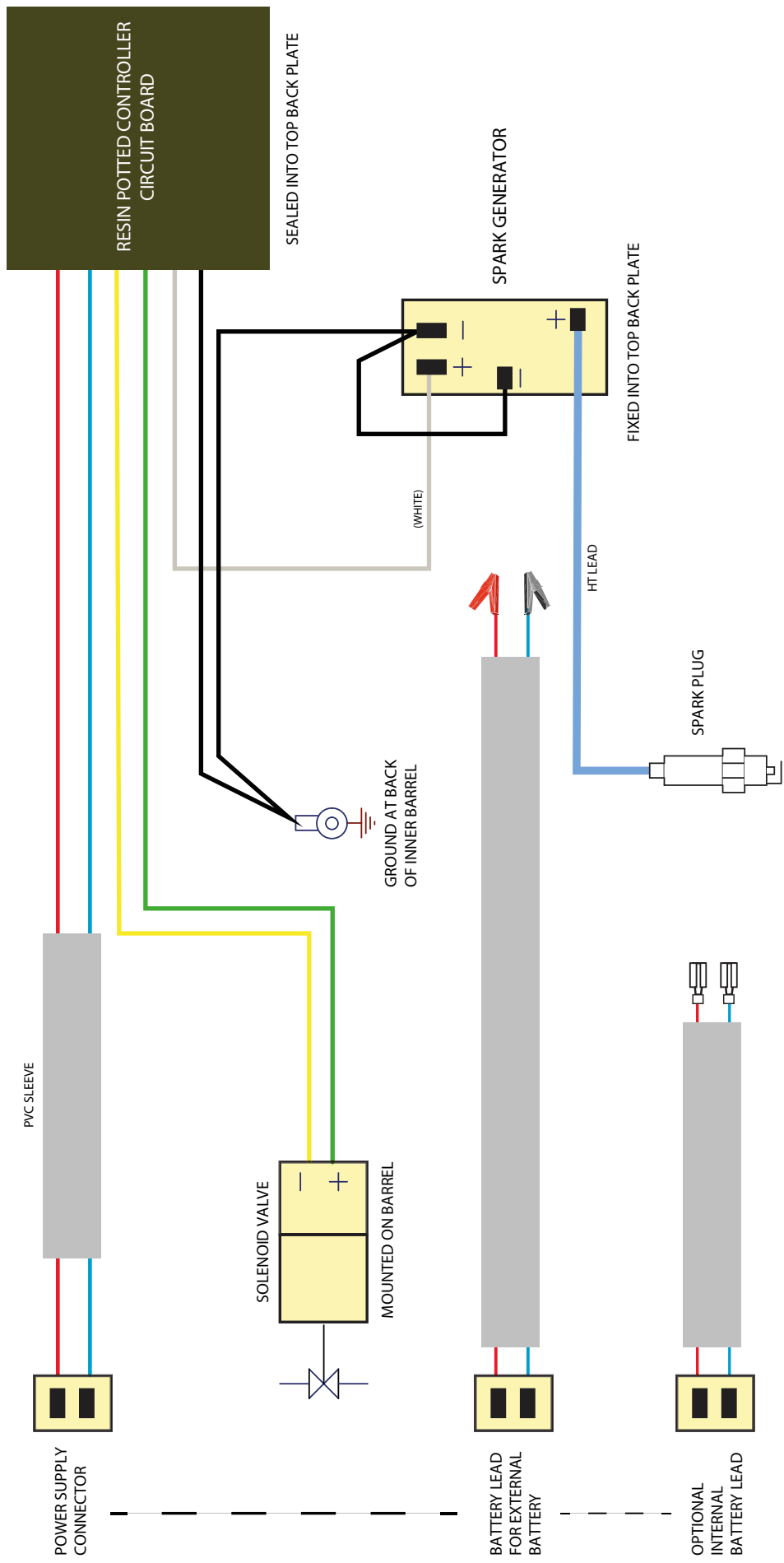

Parts Lists

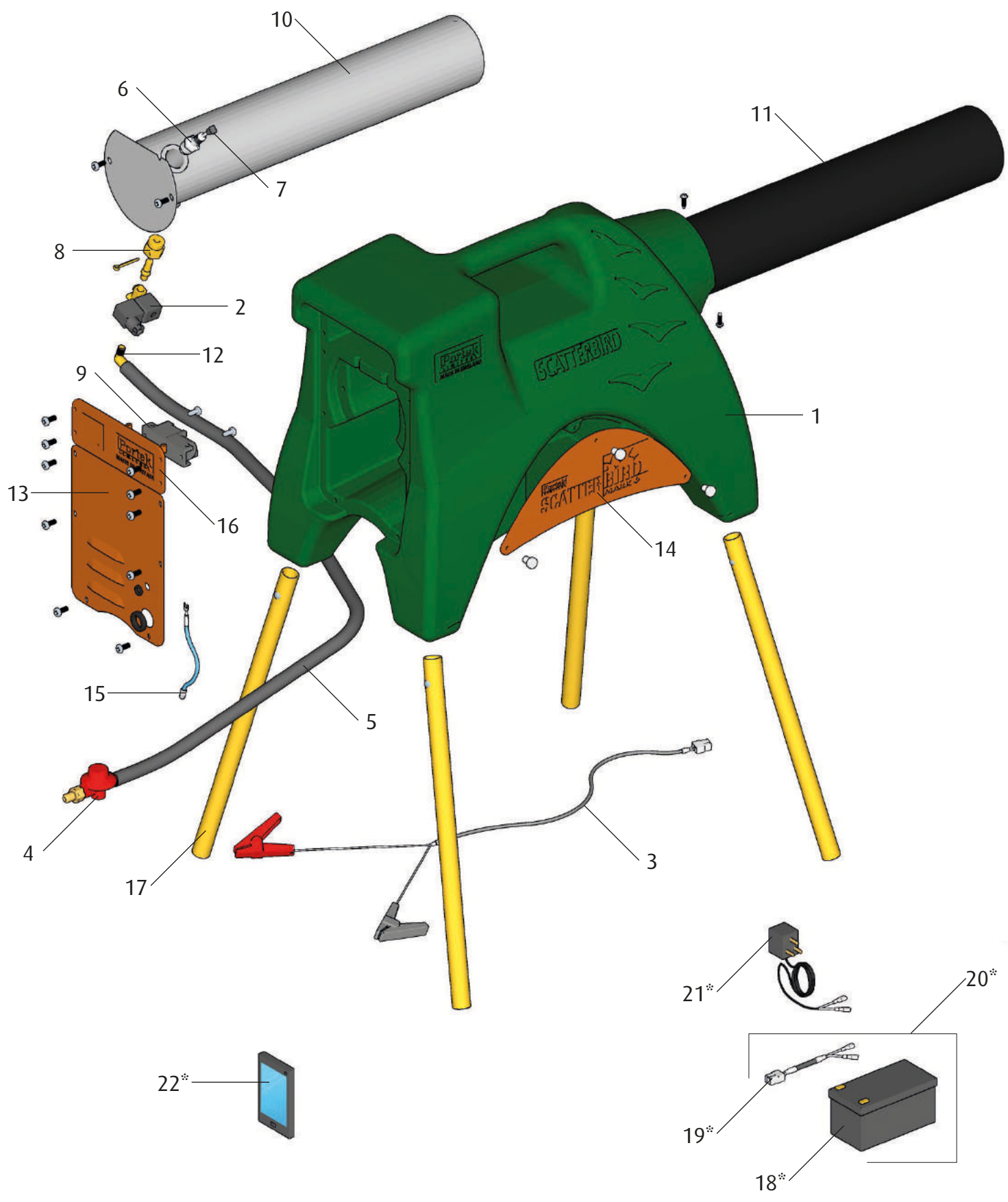

Parts Lists

No.	Description	Part No.
1	MK4 Scatterbird Moulding	033/42
2	Solenoid and Filter	033/43
3	Long Battery Lead	031/12B
4	Regulator	031/54
5	Gas Hose	031/55
6	Spark Plug BPR6ES or Equivalent	032/06
7	Spark Plug Insulated Cap	032/18A
8	Two Piece Jet complete with Split Pin	032/18
9	Spark Generator	033/04
10	Barrel Inner Assembly and 2 Screws	033/12
11	Plastic Outer Barrel with Label and 2 Screws	033/38
12	Brass Elbow Male/Female	033/14
13	Metal Backplate and 6 Screws	033/39
14	Side Plate with 3 Thumbscrews and Washers	033/41
15	High Tension (HT) Lead	033/19
16	Assembled Circuit Board including Backplate and 4 Screws	033/40
17	Leg Assembly (Set of 4)	033/30
18*	Internal Battery	034B
19*	Short Battery Lead	031/12C
20*	Internal Battery (18) + Lead (19) for Scatterbird	034
21*	Battery Charger	035
22*	Preset Remote Control	033/34

*Available as accessories

EC Certificate of Conformity

EC Declaration of Conformity

Portek Ltd, Bryn Hall, Knolton Bryn, Overton-on-Dee, Wrexham, LL13 0LF
declare that, in accordance to the following directives:

Directive 2014/30/EU (EMC Directive)

Declaration made by Stephen Morris, Designer
on 01/08/2018.



Specifications

Noise Level at 5m	120L _A max dB
Power	12 volt battery (internal or external)
Spark Plug	NGK BPR6ES (or equivalent)



Portek Ltd.
Bryn Hall, Knolton Bryn
Overton-on-Dee
Wrexham, LL13 0LF
Tel: 01234 889 454
Fax: 01234 889 464

General enquiries: sales@portek.co.uk



© 2018 Portek Ltd
Issue 1 - 08.18